





Assembly code	Assembly description	Assembly image
ASM3401A/0.D03	Cooking chamber	
ASM3413A/0.D02	External cover	
ASM3426B/0.D01	Door	
ASM8225A/0.D00	Electrical system	



ASM3401A/0.D03 - Cooking chamber - FRONT

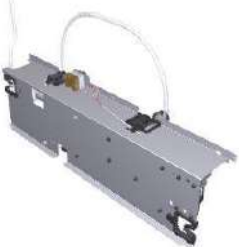
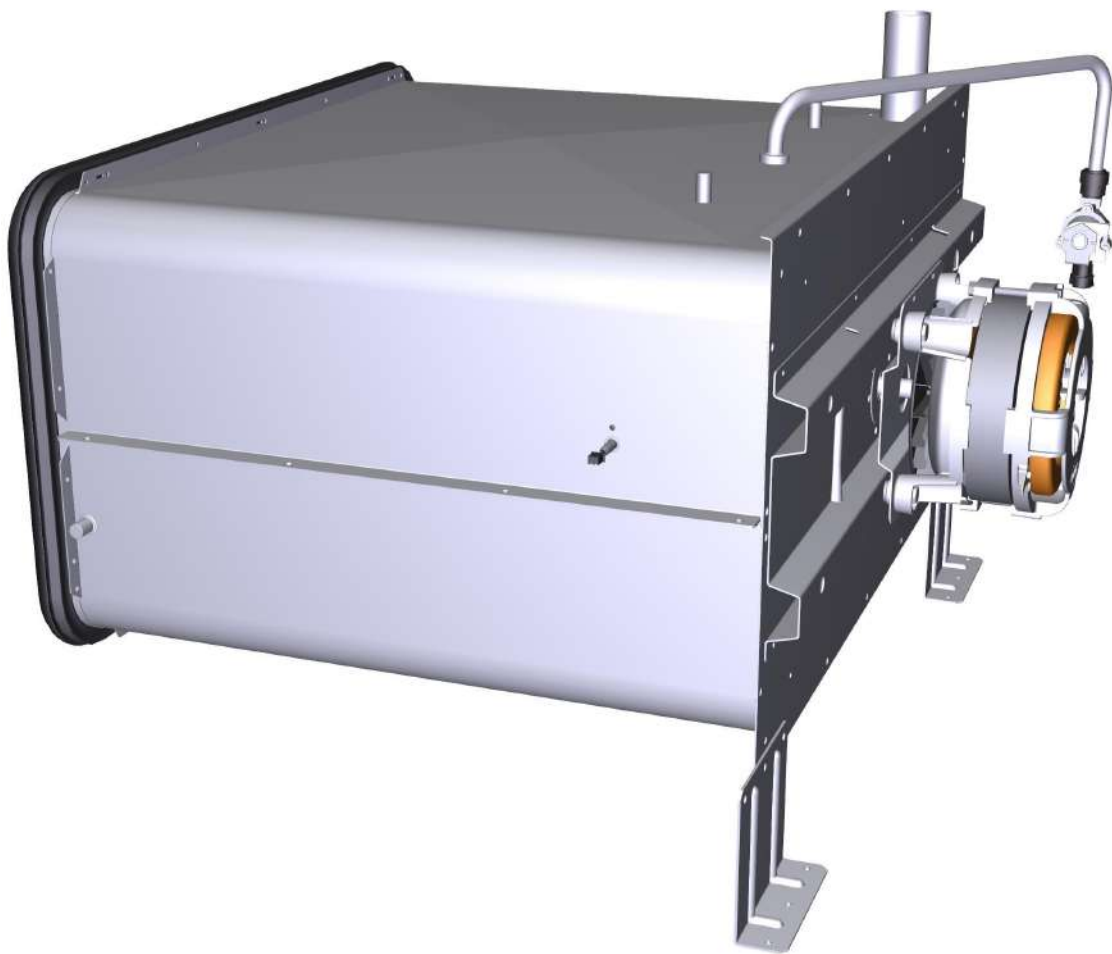





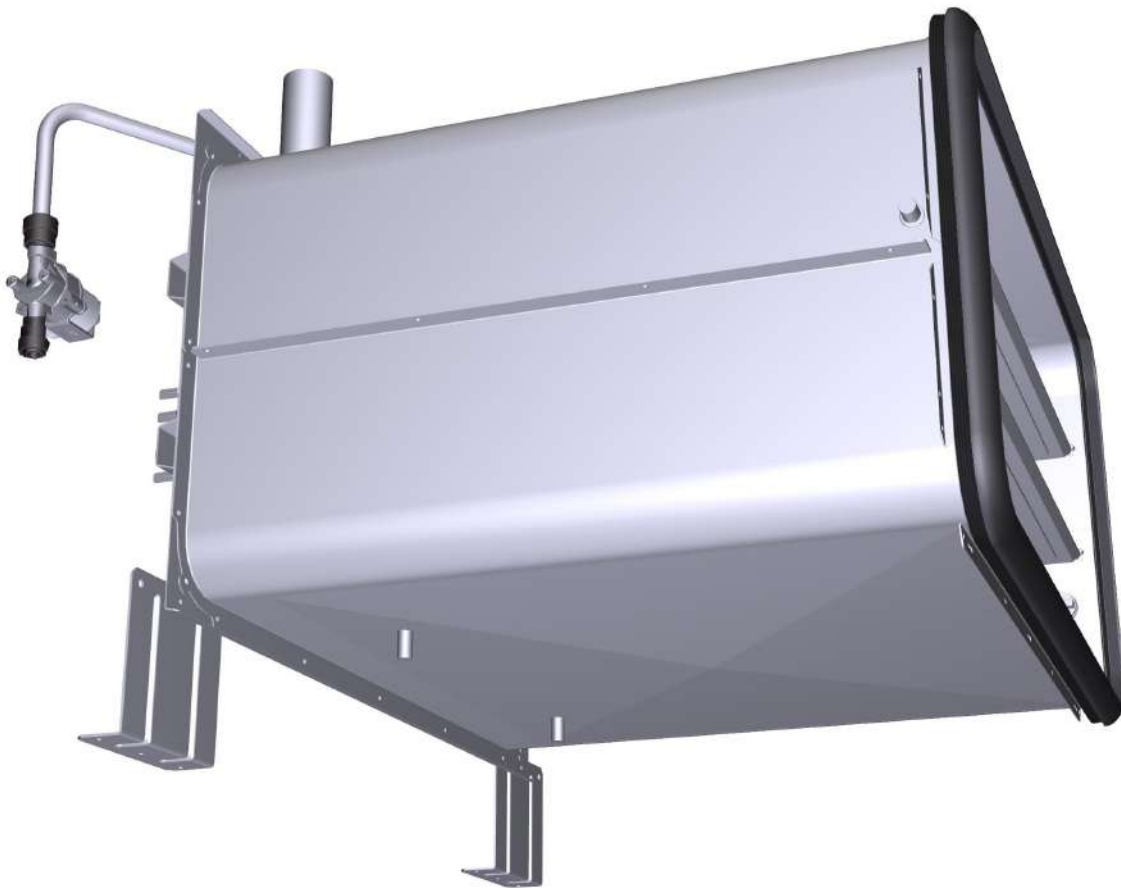





ASM3401A/0.D03 - Cooking chamber - REAR





COMPONENT			SPARE PART																																		
Code	Description	Image	Code	Description	Kit components																																
0C1542A	SHOP.PRO 03HS CHAMBER BACK WALL CORNER		0C1542A0	SHOP.PRO 03HS CHAMBER BACK WALL CORNER																																	
0G1651B	STEFANIA SP FAN GUARD		K0G1651B	STEFANIA BLSP FAN GUARD+HUMIDITY PIPE	<table border="1"> <thead> <tr> <th>Code</th> <th>Description</th> <th>Qty</th> <th>UOM</th> </tr> </thead> <tbody> <tr> <td>0G1651B0</td> <td>STEFANIA SP FAN GUARD</td> <td>1.000</td> <td>PC</td> </tr> <tr> <td>TB1577B0</td> <td>STEFANIA SP INTERNAL HUMIDITY PIP</td> <td>1.000</td> <td>PC</td> </tr> <tr> <td>VI1220A1</td> <td>4,2x12 TCB SELF-TAPPIN G SCREW</td> <td>2.000</td> <td>PC</td> </tr> </tbody> </table>	Code	Description	Qty	UOM	0G1651B0	STEFANIA SP FAN GUARD	1.000	PC	TB1577B0	STEFANIA SP INTERNAL HUMIDITY PIP	1.000	PC	VI1220A1	4,2x12 TCB SELF-TAPPIN G SCREW	2.000	PC																
Code	Description	Qty	UOM																																		
0G1651B0	STEFANIA SP FAN GUARD	1.000	PC																																		
TB1577B0	STEFANIA SP INTERNAL HUMIDITY PIP	1.000	PC																																		
VI1220A1	4,2x12 TCB SELF-TAPPIN G SCREW	2.000	PC																																		
0H7875A	SHOP.PRO MUFFLE SUPPORT BRACKET		0H7875A1	SHOP.PRO MUFFLE SUPPORT BRACKET																																	
TR1105A	L1000 PT100 TEMPERATURE PROBE		KTR1105A	PT100 L1000 TEMPERATURE PROBE KIT	<table border="1"> <thead> <tr> <th>Code</th> <th>Description</th> <th>Qty</th> <th>UOM</th> </tr> </thead> <tbody> <tr> <td>0H4302A0</td> <td>PROBES SILICON HOLDER</td> <td>1.000</td> <td>PC</td> </tr> <tr> <td>GN1120A1</td> <td>NTC TEMPERATUR E PROBE SEAL</td> <td>1.000</td> <td>PC</td> </tr> <tr> <td>GN1285A0</td> <td>NTC TEMPERATUR E PROBE SEALING</td> <td>1.000</td> <td>PC</td> </tr> <tr> <td>SL1045A0</td> <td>S57 BLACK SILICONE - 80ml CARTRIDGE</td> <td>1.000</td> <td>PC</td> </tr> <tr> <td>TR1105A4</td> <td>L1000 PT100 TEMPERATUR E PROBE</td> <td>1.000</td> <td>PC</td> </tr> <tr> <td>VI1220A1</td> <td>4,2x12 TCB SELF-TAPPIN G SCREW</td> <td>2.000</td> <td>PC</td> </tr> <tr> <td>VM1464A1</td> <td>CT BT TEMPERATUR E PROBE COVER</td> <td>1.000</td> <td>PC</td> </tr> </tbody> </table>	Code	Description	Qty	UOM	0H4302A0	PROBES SILICON HOLDER	1.000	PC	GN1120A1	NTC TEMPERATUR E PROBE SEAL	1.000	PC	GN1285A0	NTC TEMPERATUR E PROBE SEALING	1.000	PC	SL1045A0	S57 BLACK SILICONE - 80ml CARTRIDGE	1.000	PC	TR1105A4	L1000 PT100 TEMPERATUR E PROBE	1.000	PC	VI1220A1	4,2x12 TCB SELF-TAPPIN G SCREW	2.000	PC	VM1464A1	CT BT TEMPERATUR E PROBE COVER	1.000	PC
Code	Description	Qty	UOM																																		
0H4302A0	PROBES SILICON HOLDER	1.000	PC																																		
GN1120A1	NTC TEMPERATUR E PROBE SEAL	1.000	PC																																		
GN1285A0	NTC TEMPERATUR E PROBE SEALING	1.000	PC																																		
SL1045A0	S57 BLACK SILICONE - 80ml CARTRIDGE	1.000	PC																																		
TR1105A4	L1000 PT100 TEMPERATUR E PROBE	1.000	PC																																		
VI1220A1	4,2x12 TCB SELF-TAPPIN G SCREW	2.000	PC																																		
VM1464A1	CT BT TEMPERATUR E PROBE COVER	1.000	PC																																		





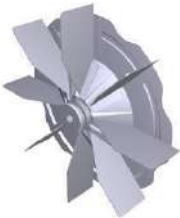

COMPONENT			SPARE PART														
Code	Description	Image	Code	Description	Kit components												
TR1105A	L1000 PT100 TEMPERATURE PROBE		KTR1105A	PT100 L1000 TEMPERATURE PROBE KIT	<table border="1"> <thead> <tr> <th>Code</th> <th>Description</th> <th>Qty</th> <th>UOM</th> </tr> </thead> <tbody> <tr> <td>VM1465A1</td> <td>CT BT TEMPERATUR E PROBE COVER</td> <td>1.000</td> <td>PC</td> </tr> <tr> <td>VM2052A0</td> <td>LM CORE PROBE COVE</td> <td>1.000</td> <td>PC</td> </tr> </tbody> </table>	Code	Description	Qty	UOM	VM1465A1	CT BT TEMPERATUR E PROBE COVER	1.000	PC	VM2052A0	LM CORE PROBE COVE	1.000	PC
Code	Description	Qty	UOM														
VM1465A1	CT BT TEMPERATUR E PROBE COVER	1.000	PC														
VM2052A0	LM CORE PROBE COVE	1.000	PC														
EL1251A	1-WAY WATER SOLENOID VALVE		KEL1251A	JG D8-D10 1 WAY SOLENOID VALVE KI	<table border="1"> <thead> <tr> <th>Code</th> <th>Description</th> <th>Qty</th> <th>UOM</th> </tr> </thead> <tbody> <tr> <td>EL1251A0</td> <td>1-WAY WATER SOLENOID VALVE</td> <td>1.000</td> <td>PC</td> </tr> </tbody> </table>	Code	Description	Qty	UOM	EL1251A0	1-WAY WATER SOLENOID VALVE	1.000	PC				
Code	Description	Qty	UOM														
EL1251A0	1-WAY WATER SOLENOID VALVE	1.000	PC														
0H3020A	MOTOR SHAFT SEALING DISC		0H3020A1	MOTOR SHAFT SEALING DISC													
0H7170A	MM MOTOR GLASS WOOL PLATE		0H7170A0	MM MOTOR GLASS WOOL PLATE													
GN1547A	SHAFT GASKET D11.8		KGN1547A	D11.6 MOTOR SHAFT GASKET 3PCS KIT	<table border="1"> <thead> <tr> <th>Code</th> <th>Description</th> <th>Qty</th> <th>UOM</th> </tr> </thead> <tbody> <tr> <td>GN1547A1</td> <td>SHAFT GASKET D11.8</td> <td>3.000</td> <td>PC</td> </tr> </tbody> </table>	Code	Description	Qty	UOM	GN1547A1	SHAFT GASKET D11.8	3.000	PC				
Code	Description	Qty	UOM														
GN1547A1	SHAFT GASKET D11.8	3.000	PC														



COMPONENT			SPARE PART																															
Code	Description	Image	Code	Description	Kit components																													
MT1012A	330W 230V MOTOR		KVN1130A	LUX ≤08.2017/L.MISS/S.5/ 5E MOTOR KIT	<table border="1"> <thead> <tr> <th>Code</th> <th>Description</th> <th>Qty</th> <th>UOM</th> </tr> </thead> <tbody> <tr> <td>0H8118A0</td> <td>XEVL MOTOR SHAFT DISC</td> <td>1.000</td> <td>PC</td> </tr> <tr> <td>GN1140A3</td> <td>MOLDED MOTOR HOLDER GASKET</td> <td>1.000</td> <td>PC</td> </tr> <tr> <td>VI1034A0</td> <td>STAINLESS STEEL WASHER 8.4x16x1</td> <td>1.000</td> <td>PC</td> </tr> <tr> <td>VI1256A0</td> <td>M8 DIN 980M ST. STEEL SELF LOCKING NUT</td> <td>1.000</td> <td>PC</td> </tr> <tr> <td>VM2196A0</td> <td>MOTOR NUT FASTENING BUSHING</td> <td>1.000</td> <td>PC</td> </tr> <tr> <td>VN1130A1</td> <td>330W 230V 50/60HZ MOTO</td> <td>1.000</td> <td>PC</td> </tr> </tbody> </table>	Code	Description	Qty	UOM	0H8118A0	XEVL MOTOR SHAFT DISC	1.000	PC	GN1140A3	MOLDED MOTOR HOLDER GASKET	1.000	PC	VI1034A0	STAINLESS STEEL WASHER 8.4x16x1	1.000	PC	VI1256A0	M8 DIN 980M ST. STEEL SELF LOCKING NUT	1.000	PC	VM2196A0	MOTOR NUT FASTENING BUSHING	1.000	PC	VN1130A1	330W 230V 50/60HZ MOTO	1.000	PC	
			Code	Description	Qty	UOM																												
0H8118A0	XEVL MOTOR SHAFT DISC	1.000	PC																															
GN1140A3	MOLDED MOTOR HOLDER GASKET	1.000	PC																															
VI1034A0	STAINLESS STEEL WASHER 8.4x16x1	1.000	PC																															
VI1256A0	M8 DIN 980M ST. STEEL SELF LOCKING NUT	1.000	PC																															
VM2196A0	MOTOR NUT FASTENING BUSHING	1.000	PC																															
VN1130A1	330W 230V 50/60HZ MOTO	1.000	PC																															
KMT1012A	LUX >08.2017 / MIND.MAPS 330W MOTOR KIT	<table border="1"> <thead> <tr> <th>Code</th> <th>Description</th> <th>Qty</th> <th>UOM</th> </tr> </thead> <tbody> <tr> <td>0H2842A0</td> <td>MT1012 CENTERING JI</td> <td>1.000</td> <td>PC</td> </tr> <tr> <td>0H8118A0</td> <td>XEVL MOTOR SHAFT DISC</td> <td>1.000</td> <td>PC</td> </tr> <tr> <td>GN1140A3</td> <td>MOLDED MOTOR HOLDER GASKET</td> <td>1.000</td> <td>PC</td> </tr> <tr> <td>MT1012A0</td> <td>330W 230V MOTOR</td> <td>1.000</td> <td>PC</td> </tr> <tr> <td>VI1077A1</td> <td>SCREW M6x12 TE INOX</td> <td>1.000</td> <td>PC</td> </tr> <tr> <td>VI1521A0</td> <td>STAINLESS STEEL WASHER D=6 6592</td> <td>1.000</td> <td>PC</td> </tr> <tr> <td>VI1966A1</td> <td>M4x14 FLATHEAD SCREW</td> <td>1.000</td> <td>PC</td> </tr> </tbody> </table>	Code	Description	Qty	UOM	0H2842A0	MT1012 CENTERING JI	1.000	PC	0H8118A0	XEVL MOTOR SHAFT DISC	1.000	PC	GN1140A3	MOLDED MOTOR HOLDER GASKET	1.000	PC	MT1012A0	330W 230V MOTOR	1.000	PC	VI1077A1	SCREW M6x12 TE INOX	1.000	PC	VI1521A0	STAINLESS STEEL WASHER D=6 6592	1.000	PC	VI1966A1	M4x14 FLATHEAD SCREW	1.000	PC
Code	Description	Qty	UOM																															
0H2842A0	MT1012 CENTERING JI	1.000	PC																															
0H8118A0	XEVL MOTOR SHAFT DISC	1.000	PC																															
GN1140A3	MOLDED MOTOR HOLDER GASKET	1.000	PC																															
MT1012A0	330W 230V MOTOR	1.000	PC																															
VI1077A1	SCREW M6x12 TE INOX	1.000	PC																															
VI1521A0	STAINLESS STEEL WASHER D=6 6592	1.000	PC																															
VI1966A1	M4x14 FLATHEAD SCREW	1.000	PC																															
VN1172A	M8 NUT 8 BLADES H40 D195 FAN		KVN1172A	D195 H40 M8 NUT 8 BLADES FAN KIT	<table border="1"> <thead> <tr> <th>Code</th> <th>Description</th> <th>Qty</th> <th>UOM</th> </tr> </thead> <tbody> <tr> <td>VI1077A1</td> <td>SCREW M6x12 TE INOX</td> <td>1.000</td> <td>PC</td> </tr> <tr> <td>VI1521A0</td> <td>STAINLESS STEEL WASHER D=6 6592</td> <td>1.000</td> <td>PC</td> </tr> <tr> <td>VN1172A0</td> <td>M8 NUT 8 BLADES H40 D195 FAN</td> <td>1.000</td> <td>PC</td> </tr> </tbody> </table>	Code	Description	Qty	UOM	VI1077A1	SCREW M6x12 TE INOX	1.000	PC	VI1521A0	STAINLESS STEEL WASHER D=6 6592	1.000	PC	VN1172A0	M8 NUT 8 BLADES H40 D195 FAN	1.000	PC													
Code	Description	Qty	UOM																															
VI1077A1	SCREW M6x12 TE INOX	1.000	PC																															
VI1521A0	STAINLESS STEEL WASHER D=6 6592	1.000	PC																															
VN1172A0	M8 NUT 8 BLADES H40 D195 FAN	1.000	PC																															

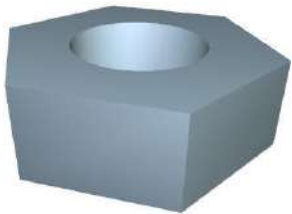

COMPONENT			SPARE PART																						
Code	Description	Image	Code	Description	Kit components																				
RS1282B	RS1282B0		KRS1282B	4TURN HEAT ELEM 2700W 230V+260W 135V KIT	<table border="1"> <thead> <tr> <th>Code</th> <th>Description</th> <th>Qty</th> <th>UOM</th> </tr> </thead> <tbody> <tr> <td>GN1327A0</td> <td>HEATING ELEMENT GASKET</td> <td>1.000</td> <td>PC</td> </tr> <tr> <td>RS1282B0</td> <td>RS1282B0</td> <td>1.000</td> <td>PC</td> </tr> <tr> <td>SL1045A0</td> <td>S57 BLACK SILICONE - 80ml CARTRIDGE</td> <td>1.000</td> <td>PC</td> </tr> <tr> <td>VI1220A1</td> <td>4,2x12 TCB SELF-TAPPIN G SCREW</td> <td>2.000</td> <td>PC</td> </tr> </tbody> </table>	Code	Description	Qty	UOM	GN1327A0	HEATING ELEMENT GASKET	1.000	PC	RS1282B0	RS1282B0	1.000	PC	SL1045A0	S57 BLACK SILICONE - 80ml CARTRIDGE	1.000	PC	VI1220A1	4,2x12 TCB SELF-TAPPIN G SCREW	2.000	PC
					Code	Description	Qty	UOM																	
					GN1327A0	HEATING ELEMENT GASKET	1.000	PC																	
					RS1282B0	RS1282B0	1.000	PC																	
SL1045A0	S57 BLACK SILICONE - 80ml CARTRIDGE	1.000	PC																						
VI1220A1	4,2x12 TCB SELF-TAPPIN G SCREW	2.000	PC																						
<table border="1"> <thead> <tr> <th>Code</th> <th>Description</th> <th>Qty</th> <th>UOM</th> </tr> </thead> <tbody> <tr> <td>GRL1005A2</td> <td>LineMiss Stefania RIGHT/LEFT LAT. GRID</td> <td>2.000</td> <td>PC</td> </tr> </tbody> </table>	Code	Description	Qty	UOM	GRL1005A2	LineMiss Stefania RIGHT/LEFT LAT. GRID	2.000	PC																	
Code	Description	Qty	UOM																						
GRL1005A2	LineMiss Stefania RIGHT/LEFT LAT. GRID	2.000	PC																						
<table border="1"> <thead> <tr> <th>Code</th> <th>Description</th> <th>Qty</th> <th>UOM</th> </tr> </thead> <tbody> <tr> <td>VM1815A0</td> <td>LATERAL SUPPORTS FIXING BOLT</td> <td>10.000</td> <td>PC</td> </tr> </tbody> </table>	Code	Description	Qty	UOM	VM1815A0	LATERAL SUPPORTS FIXING BOLT	10.000	PC																	
Code	Description	Qty	UOM																						
VM1815A0	LATERAL SUPPORTS FIXING BOLT	10.000	PC																						
<table border="1"> <thead> <tr> <th>Code</th> <th>Description</th> <th>Qty</th> <th>UOM</th> </tr> </thead> <tbody> <tr> <td>GN1596A1</td> <td>GN1596A1</td> <td>1.000</td> <td>PC</td> </tr> <tr> <td>VM2277A0</td> <td>DOOR SEAL KIT INTERNAL CONNECTION</td> <td>1.000</td> <td>PC</td> </tr> </tbody> </table>	Code	Description	Qty	UOM	GN1596A1	GN1596A1	1.000	PC	VM2277A0	DOOR SEAL KIT INTERNAL CONNECTION	1.000	PC													
Code	Description	Qty	UOM																						
GN1596A1	GN1596A1	1.000	PC																						
VM2277A0	DOOR SEAL KIT INTERNAL CONNECTION	1.000	PC																						
GRL1005A	LineMiss Stefania RIGHT/LEFT LAT. GRID		KGRL1005A	R/L CHROM. PLATED LATERAL SUPP KIT	<table border="1"> <thead> <tr> <th>Code</th> <th>Description</th> <th>Qty</th> <th>UOM</th> </tr> </thead> <tbody> <tr> <td>GRL1005A2</td> <td>LineMiss Stefania RIGHT/LEFT LAT. GRID</td> <td>2.000</td> <td>PC</td> </tr> </tbody> </table>	Code	Description	Qty	UOM	GRL1005A2	LineMiss Stefania RIGHT/LEFT LAT. GRID	2.000	PC												
Code	Description	Qty	UOM																						
GRL1005A2	LineMiss Stefania RIGHT/LEFT LAT. GRID	2.000	PC																						
VM1815A	LATERAL SUPPORTS FIXING BOLT		KVM1815A	MISS/MICRO/S4/S3 THUMB SCREW 10 PCS KIT	<table border="1"> <thead> <tr> <th>Code</th> <th>Description</th> <th>Qty</th> <th>UOM</th> </tr> </thead> <tbody> <tr> <td>VM1815A0</td> <td>LATERAL SUPPORTS FIXING BOLT</td> <td>10.000</td> <td>PC</td> </tr> </tbody> </table>	Code	Description	Qty	UOM	VM1815A0	LATERAL SUPPORTS FIXING BOLT	10.000	PC												
Code	Description	Qty	UOM																						
VM1815A0	LATERAL SUPPORTS FIXING BOLT	10.000	PC																						
GN1596A	GN1596A1		KG1596A	BL SHOP.PRO STEFANIA DOOR GASKET KIT	<table border="1"> <thead> <tr> <th>Code</th> <th>Description</th> <th>Qty</th> <th>UOM</th> </tr> </thead> <tbody> <tr> <td>GN1596A1</td> <td>GN1596A1</td> <td>1.000</td> <td>PC</td> </tr> <tr> <td>VM2277A0</td> <td>DOOR SEAL KIT INTERNAL CONNECTION</td> <td>1.000</td> <td>PC</td> </tr> </tbody> </table>	Code	Description	Qty	UOM	GN1596A1	GN1596A1	1.000	PC	VM2277A0	DOOR SEAL KIT INTERNAL CONNECTION	1.000	PC								
Code	Description	Qty	UOM																						
GN1596A1	GN1596A1	1.000	PC																						
VM2277A0	DOOR SEAL KIT INTERNAL CONNECTION	1.000	PC																						
RC1170A	M14 H=7 CH=22 STAINLESS STEEL NUT		KRC1170A	M14 H8 CH22 NUT - 10 PCS. KIT	<table border="1"> <thead> <tr> <th>Code</th> <th>Description</th> <th>Qty</th> <th>UOM</th> </tr> </thead> <tbody> <tr> <td>RC1170A1</td> <td>M14 H=7 CH=22 STAINLESS STEEL NUT</td> <td>10.000</td> <td>PC</td> </tr> </tbody> </table>	Code	Description	Qty	UOM	RC1170A1	M14 H=7 CH=22 STAINLESS STEEL NUT	10.000	PC												
Code	Description	Qty	UOM																						
RC1170A1	M14 H=7 CH=22 STAINLESS STEEL NUT	10.000	PC																						



COMPONENT			SPARE PART		
<i>Code</i>	<i>Description</i>	<i>Image</i>	<i>Code</i>	<i>Description</i>	<i>Kit components</i>
TB1568A	ARI-STE-ROS SP WELDED EXT HUMIDITY PIPE		TB1568A0	ARI-STE-ROS SP WELDED EXT HUMIDITY PIPE	
TB1574A	FUME CHIMNEY D30 SHOP PRO		TB1574A0	FUME CHIMNEY D30 SHOP PRO	
TB1577B	STEFANIA SP INTERNAL HUMIDITY PIPE		TB1577B0	STEFANIA SP INTERNAL HUMIDITY PIPE	



ASM3413A/0.D02 - External cover - FRONT













ASM3413A/0.D02 - External cover - REAR





COMPONENT			SPARE PART		
Code	Description	Image	Code	Description	Kit components
0D2406B	0D2406B1		0D2406B1	0D2406B1	
0D2410A	SP600 INF FRONT PROFILE RIGHT-LEFT DOOR		0D2410A0	SP600 INF FRONT PROFILE RIGHT-LEFT DOOR	
0E1381A	SP600 EXTERNAL BOTTOM PANEL		0E1381A1	SP600 EXTERNAL BOTTOM PANEL	
0F1541B	STEFANIA SP BACK PANEL		0F1541B0	STEFANIA SP BACK PANEL	
0H7995A	0H7995A1		0H7995A1	0H7995A1	



COMPONENT			SPARE PART																						
Code	Description	Image	Code	Description	Kit components																				
VM1750A	BRASS COMB CLAM		KVM1750A	COMB TERMINAL BLOCK KIT	<table border="1"> <thead> <tr> <th>Code</th> <th>Description</th> <th>Qty</th> <th>UOM</th> </tr> </thead> <tbody> <tr> <td>VI1040A0</td> <td>INDENTED INTERNAL WASHER D=6 ZN</td> <td>2.000</td> <td>PC</td> </tr> <tr> <td>VM1750A0</td> <td>BRASS COMB CLAMP</td> <td>1.000</td> <td>PC</td> </tr> </tbody> </table>	Code	Description	Qty	UOM	VI1040A0	INDENTED INTERNAL WASHER D=6 ZN	2.000	PC	VM1750A0	BRASS COMB CLAMP	1.000	PC								
Code	Description	Qty	UOM																						
VI1040A0	INDENTED INTERNAL WASHER D=6 ZN	2.000	PC																						
VM1750A0	BRASS COMB CLAMP	1.000	PC																						
CE1297A	BLSP ELECTROMECHANICAL LOCK CABLE		KCE1297A	BL SHOP.PRO CABLE LOCK KIT	<table border="1"> <thead> <tr> <th>Code</th> <th>Description</th> <th>Qty</th> <th>UOM</th> </tr> </thead> <tbody> <tr> <td>CE1295A1</td> <td>CABLE FOR ELECTROMAGNETIC LOCKING SYSTEM</td> <td>1.000</td> <td>PC</td> </tr> <tr> <td>CE1735A0</td> <td>MINIFIT FEMALE END FITTING</td> <td>4.000</td> <td>PC</td> </tr> <tr> <td>CE1746A0</td> <td>2 WAYS MALE MINIFIT CONNECTOR</td> <td>1.000</td> <td>PC</td> </tr> <tr> <td>CE1750A0</td> <td>3 WAYS MALE MINIFIT CONNECTOR</td> <td>1.000</td> <td>PC</td> </tr> </tbody> </table>	Code	Description	Qty	UOM	CE1295A1	CABLE FOR ELECTROMAGNETIC LOCKING SYSTEM	1.000	PC	CE1735A0	MINIFIT FEMALE END FITTING	4.000	PC	CE1746A0	2 WAYS MALE MINIFIT CONNECTOR	1.000	PC	CE1750A0	3 WAYS MALE MINIFIT CONNECTOR	1.000	PC
Code	Description	Qty	UOM																						
CE1295A1	CABLE FOR ELECTROMAGNETIC LOCKING SYSTEM	1.000	PC																						
CE1735A0	MINIFIT FEMALE END FITTING	4.000	PC																						
CE1746A0	2 WAYS MALE MINIFIT CONNECTOR	1.000	PC																						
CE1750A0	3 WAYS MALE MINIFIT CONNECTOR	1.000	PC																						
0H1234A	0H1234A2		K0H1234A	SHOP.PRO LOCK HOLDING PLATE KIT	<table border="1"> <thead> <tr> <th>Code</th> <th>Description</th> <th>Qty</th> <th>UOM</th> </tr> </thead> <tbody> <tr> <td>0H1234A2</td> <td>0H1234A2</td> <td>1.000</td> <td>PC</td> </tr> <tr> <td>VI1014A0</td> <td>STAINLESS STEEL WASHER 4.5X9X0.8</td> <td>2.000</td> <td>PC</td> </tr> <tr> <td>VI1024A0</td> <td>SCREW M4x12 TCB + INOX DIN 7985</td> <td>2.000</td> <td>PC</td> </tr> <tr> <td>VI1850A0</td> <td>TCB M4x6 SCREW</td> <td>2.000</td> <td>PC</td> </tr> </tbody> </table>	Code	Description	Qty	UOM	0H1234A2	0H1234A2	1.000	PC	VI1014A0	STAINLESS STEEL WASHER 4.5X9X0.8	2.000	PC	VI1024A0	SCREW M4x12 TCB + INOX DIN 7985	2.000	PC	VI1850A0	TCB M4x6 SCREW	2.000	PC
Code	Description	Qty	UOM																						
0H1234A2	0H1234A2	1.000	PC																						
VI1014A0	STAINLESS STEEL WASHER 4.5X9X0.8	2.000	PC																						
VI1024A0	SCREW M4x12 TCB + INOX DIN 7985	2.000	PC																						
VI1850A0	TCB M4x6 SCREW	2.000	PC																						
CR1035A	L.Miss Matic ELECTROMECHANICAL LOCK		KCR1035A	LM MATIC ELECTROMECHANICAL LOCK KIT	<table border="1"> <thead> <tr> <th>Code</th> <th>Description</th> <th>Qty</th> <th>UOM</th> </tr> </thead> <tbody> <tr> <td>0H10283A0</td> <td></td> <td>1.000</td> <td>PC</td> </tr> <tr> <td>CR1035A0</td> <td>L.Miss Matic ELECTROMECHANICAL LOCK</td> <td>1.000</td> <td>PC</td> </tr> </tbody> </table>	Code	Description	Qty	UOM	0H10283A0		1.000	PC	CR1035A0	L.Miss Matic ELECTROMECHANICAL LOCK	1.000	PC								
Code	Description	Qty	UOM																						
0H10283A0		1.000	PC																						
CR1035A0	L.Miss Matic ELECTROMECHANICAL LOCK	1.000	PC																						







COMPONENT			SPARE PART														
Code	Description	Image	Code	Description	Kit components												
VM2154A	VM2154A2		KVM2154A	LINEMISS MATIC-TOP LOCKING COVER KI	<table border="1"> <thead> <tr> <th>Code</th> <th>Description</th> <th>Qty</th> <th>UOM</th> </tr> </thead> <tbody> <tr> <td>0H1234A2</td> <td>0H1234A2</td> <td>1.000</td> <td>PC</td> </tr> <tr> <td>VM2154A2</td> <td>VM2154A2</td> <td>1.000</td> <td>PC</td> </tr> </tbody> </table>	Code	Description	Qty	UOM	0H1234A2	0H1234A2	1.000	PC	VM2154A2	VM2154A2	1.000	PC
Code	Description	Qty	UOM														
0H1234A2	0H1234A2	1.000	PC														
VM2154A2	VM2154A2	1.000	PC														
VM2502A	BAKERLUX SHOP.PRO CHIMNEY RING		KVM2502A	BAKERLUX SHOP.PRO CHIMNEY RING KIT	<table border="1"> <thead> <tr> <th>Code</th> <th>Description</th> <th>Qty</th> <th>UOM</th> </tr> </thead> <tbody> <tr> <td>VM2502A0</td> <td>BAKERLUX SHOP.PRO CHIMNEY RIN</td> <td>1.000</td> <td>PC</td> </tr> </tbody> </table>	Code	Description	Qty	UOM	VM2502A0	BAKERLUX SHOP.PRO CHIMNEY RIN	1.000	PC				
Code	Description	Qty	UOM														
VM2502A0	BAKERLUX SHOP.PRO CHIMNEY RIN	1.000	PC														
VM2495A	SP COOLING FAN SUPPORT		KVM2495A	COOLING FAN SUPPORT KIT	<table border="1"> <thead> <tr> <th>Code</th> <th>Description</th> <th>Qty</th> <th>UOM</th> </tr> </thead> <tbody> <tr> <td>VI1220A1</td> <td>4,2x12 TCB SELF-TAPPIN G.SCREW</td> <td>2.000</td> <td>PC</td> </tr> <tr> <td>VM2495A0</td> <td>SP COOLING FAN SUPPORT</td> <td>1.000</td> <td>PC</td> </tr> </tbody> </table>	Code	Description	Qty	UOM	VI1220A1	4,2x12 TCB SELF-TAPPIN G.SCREW	2.000	PC	VM2495A0	SP COOLING FAN SUPPORT	1.000	PC
Code	Description	Qty	UOM														
VI1220A1	4,2x12 TCB SELF-TAPPIN G.SCREW	2.000	PC														
VM2495A0	SP COOLING FAN SUPPORT	1.000	PC														
VN1175A	230V 50/60Hz 120x120 COOLING DOWN FAN		KVN1175A	120x120 230V 50/60Hz COOLING FAN KIT	<table border="1"> <thead> <tr> <th>Code</th> <th>Description</th> <th>Qty</th> <th>UOM</th> </tr> </thead> <tbody> <tr> <td>VN1175A0</td> <td>230V 50/60Hz 120x120 COOLING DOWN FAN</td> <td>1.000</td> <td>PC</td> </tr> </tbody> </table>	Code	Description	Qty	UOM	VN1175A0	230V 50/60Hz 120x120 COOLING DOWN FAN	1.000	PC				
Code	Description	Qty	UOM														
VN1175A0	230V 50/60Hz 120x120 COOLING DOWN FAN	1.000	PC														
VM2481A	FRONT EXTERNAL COVER LEFT CAP S		KVM2481A	BL SP LEFT EXT COVER FRONT PANEL CAP KIT	<table border="1"> <thead> <tr> <th>Code</th> <th>Description</th> <th>Qty</th> <th>UOM</th> </tr> </thead> <tbody> <tr> <td>VM2481A0</td> <td>FRONT EXTERNAL COVER LEFT CAP SP</td> <td>1.000</td> <td>PC</td> </tr> </tbody> </table>	Code	Description	Qty	UOM	VM2481A0	FRONT EXTERNAL COVER LEFT CAP SP	1.000	PC				
Code	Description	Qty	UOM														
VM2481A0	FRONT EXTERNAL COVER LEFT CAP SP	1.000	PC														



COMPONENT			SPARE PART										
Code	Description	Image	Code	Description	Kit components								
VM2480A	FRONT EXTERNAL COVER RIGHT CAP SP		KVM2480A	BL SP RIGHT EXT COVER FRONT PANEL CAP	<table border="1"> <thead> <tr> <th>Code</th> <th>Description</th> <th>Qty</th> <th>UOM</th> </tr> </thead> <tbody> <tr> <td>VM2480A0</td> <td>FRONT EXTERNAL COVER RIGHT CAP SP</td> <td>1.000</td> <td>PC</td> </tr> </tbody> </table>	Code	Description	Qty	UOM	VM2480A0	FRONT EXTERNAL COVER RIGHT CAP SP	1.000	PC
Code	Description	Qty	UOM										
VM2480A0	FRONT EXTERNAL COVER RIGHT CAP SP	1.000	PC										
0H7850A	SHOP PRO DOOR COUNTERBRACKET		0H7850A0	SHOP PRO DOOR COUNTERBRACKET									
VI0515A	STAINLESS STEEL WASHER D=5 6592		VI0515A0	STAINLESS STEEL WASHER D=5 6592									
VI1995A	M5x25 ST.STEEL SCREW		VI1995A0	M5x25 ST.STEEL SCREW									
VM1240A	NYLON SUPPORT CAP		KVM1240A	4 PCS COUNTER BRACKET SUPPORT CAP KIT	<table border="1"> <thead> <tr> <th>Code</th> <th>Description</th> <th>Qty</th> <th>UOM</th> </tr> </thead> <tbody> <tr> <td>VM1240A0</td> <td>NYLON SUPPORT CAP</td> <td>4.000</td> <td>PC</td> </tr> </tbody> </table>	Code	Description	Qty	UOM	VM1240A0	NYLON SUPPORT CAP	4.000	PC
Code	Description	Qty	UOM										
VM1240A0	NYLON SUPPORT CAP	4.000	PC										



COMPONENT			SPARE PART																						
Code	Description	Image	Code	Description	Kit components																				
VM2459A	SP LATERAL DOOR UPPER BRACKET		KVM2459A	BL SP LATERAL DOOR UPPER BRACKET KIT	<table border="1"> <thead> <tr> <th>Code</th> <th>Description</th> <th>Qty</th> <th>UOM</th> </tr> </thead> <tbody> <tr> <td>VI0515A0</td> <td>STAINLESS STEEL WASHER D=5 6592</td> <td>4.000</td> <td>PC</td> </tr> <tr> <td>VI1995A0</td> <td>M5x25 ST.STEEL SCREW</td> <td>4.000</td> <td>PC</td> </tr> <tr> <td>VM2459A1</td> <td>SP LATERAL DOOR UPPER BRACKET</td> <td>1.000</td> <td>PC</td> </tr> <tr> <td>VM2460A0</td> <td>BL SP LATERAL DOOR UPPER BRACKET COVER</td> <td>1.000</td> <td>PC</td> </tr> </tbody> </table>	Code	Description	Qty	UOM	VI0515A0	STAINLESS STEEL WASHER D=5 6592	4.000	PC	VI1995A0	M5x25 ST.STEEL SCREW	4.000	PC	VM2459A1	SP LATERAL DOOR UPPER BRACKET	1.000	PC	VM2460A0	BL SP LATERAL DOOR UPPER BRACKET COVER	1.000	PC
Code	Description	Qty	UOM																						
VI0515A0	STAINLESS STEEL WASHER D=5 6592	4.000	PC																						
VI1995A0	M5x25 ST.STEEL SCREW	4.000	PC																						
VM2459A1	SP LATERAL DOOR UPPER BRACKET	1.000	PC																						
VM2460A0	BL SP LATERAL DOOR UPPER BRACKET COVER	1.000	PC																						
VM2460A	BL SP LATERAL DOOR UPPER BRACKET COVER		KVM2460A	BL SP LAT DOOR UPP BRACKET COVER 2PC KIT	<table border="1"> <thead> <tr> <th>Code</th> <th>Description</th> <th>Qty</th> <th>UOM</th> </tr> </thead> <tbody> <tr> <td>VM2460A0</td> <td>BL SP LATERAL DOOR UPPER BRACKET COVER</td> <td>1.000</td> <td>PC</td> </tr> </tbody> </table>	Code	Description	Qty	UOM	VM2460A0	BL SP LATERAL DOOR UPPER BRACKET COVER	1.000	PC												
Code	Description	Qty	UOM																						
VM2460A0	BL SP LATERAL DOOR UPPER BRACKET COVER	1.000	PC																						
0H7850A	SHOP PRO DOOR COUNTERBRACKET		0H7850A0	SHOP PRO DOOR COUNTERBRACKET																					
VI0515A	STAINLESS STEEL WASHER D=5 6592		VI0515A0	STAINLESS STEEL WASHER D=5 6592																					





COMPONENT			SPARE PART																						
Code	Description	Image	Code	Description	Kit components																				
VM1240A	NYLON SUPPORT CAP		KVM1240A	4 PCS COUNTER BRACKET SUPPORT CAP KIT	<table border="1"> <thead> <tr> <th>Code</th> <th>Description</th> <th>Qty</th> <th>UOM</th> </tr> </thead> <tbody> <tr> <td>VM1240A0</td> <td>NYLON SUPPORT CAP</td> <td>4.000</td> <td>PC</td> </tr> </tbody> </table>	Code	Description	Qty	UOM	VM1240A0	NYLON SUPPORT CAP	4.000	PC												
Code	Description	Qty	UOM																						
VM1240A0	NYLON SUPPORT CAP	4.000	PC																						
VM2457A	BL SP LATERAL DOOR LOWER BRACKET		KVM2457A	BL SP LATERAL DOOR LOWER BRACKET KIT	<table border="1"> <thead> <tr> <th>Code</th> <th>Description</th> <th>Qty</th> <th>UOM</th> </tr> </thead> <tbody> <tr> <td>VI0515A0</td> <td>STAINLESS STEEL WASHER D=5 6592</td> <td>2.000</td> <td>PC</td> </tr> <tr> <td>VI1995A0</td> <td>M5x25 ST.STEEL SCREW</td> <td>2.000</td> <td>PC</td> </tr> <tr> <td>VM2457A0</td> <td>BL SP LATERAL DOOR LOWER BRACKET</td> <td>1.000</td> <td>PC</td> </tr> <tr> <td>VM2458A0</td> <td>BL SP LATERAL DOOR LOW BRACKET COVER</td> <td>1.000</td> <td>PC</td> </tr> </tbody> </table>	Code	Description	Qty	UOM	VI0515A0	STAINLESS STEEL WASHER D=5 6592	2.000	PC	VI1995A0	M5x25 ST.STEEL SCREW	2.000	PC	VM2457A0	BL SP LATERAL DOOR LOWER BRACKET	1.000	PC	VM2458A0	BL SP LATERAL DOOR LOW BRACKET COVER	1.000	PC
Code	Description	Qty	UOM																						
VI0515A0	STAINLESS STEEL WASHER D=5 6592	2.000	PC																						
VI1995A0	M5x25 ST.STEEL SCREW	2.000	PC																						
VM2457A0	BL SP LATERAL DOOR LOWER BRACKET	1.000	PC																						
VM2458A0	BL SP LATERAL DOOR LOW BRACKET COVER	1.000	PC																						
VM2458A	BL SP LATERAL DOOR LOW BRACKET COVER		KVM2458A	BL SP LAT DOOR LOW BRACKET COVER 2PC KIT	<table border="1"> <thead> <tr> <th>Code</th> <th>Description</th> <th>Qty</th> <th>UOM</th> </tr> </thead> <tbody> <tr> <td>VM2458A0</td> <td>BL SP LATERAL DOOR LOW BRACKET COVER</td> <td>2.000</td> <td>PC</td> </tr> </tbody> </table>	Code	Description	Qty	UOM	VM2458A0	BL SP LATERAL DOOR LOW BRACKET COVER	2.000	PC												
Code	Description	Qty	UOM																						
VM2458A0	BL SP LATERAL DOOR LOW BRACKET COVER	2.000	PC																						
0H7850A	SHOP PRO DOOR COUNTERBRACKET		0H7850A0	SHOP PRO DOOR COUNTERBRACKET																					





COMPONENT			SPARE PART																						
Code	Description	Image	Code	Description	Kit components																				
VI0515A	STAINLESS STEEL WASHER D=5 6592		VI0515A0	STAINLESS STEEL WASHER D=5 6592																					
VM1240A	NYLON SUPPORT CAP		KVM1240A	4 PCS COUNTER BRACKET SUPPORT CAP KIT	<table border="1"> <thead> <tr> <th>Code</th> <th>Description</th> <th>Qty</th> <th>UOM</th> </tr> </thead> <tbody> <tr> <td>VM1240A0</td> <td>NYLON SUPPORT CAP</td> <td>4.000</td> <td>PC</td> </tr> </tbody> </table>	Code	Description	Qty	UOM	VM1240A0	NYLON SUPPORT CAP	4.000	PC												
Code	Description	Qty	UOM																						
VM1240A0	NYLON SUPPORT CAP	4.000	PC																						
VM2458A	BL SP LATERAL DOOR LOW BRACKET COVER		KVM2458A	BL SP LAT DOOR LOW BRACKET COVER 2PC KIT	<table border="1"> <thead> <tr> <th>Code</th> <th>Description</th> <th>Qty</th> <th>UOM</th> </tr> </thead> <tbody> <tr> <td>VM2458A0</td> <td>BL SP LATERAL DOOR LOW BRACKET COVER</td> <td>2.000</td> <td>PC</td> </tr> </tbody> </table>	Code	Description	Qty	UOM	VM2458A0	BL SP LATERAL DOOR LOW BRACKET COVER	2.000	PC												
Code	Description	Qty	UOM																						
VM2458A0	BL SP LATERAL DOOR LOW BRACKET COVER	2.000	PC																						
VM2469A	BL SP LATERAL DOOR HOLDER BRACKET		KVM2469A	BL SP LATERAL DOOR HOLDER BRACKET KIT	<table border="1"> <thead> <tr> <th>Code</th> <th>Description</th> <th>Qty</th> <th>UOM</th> </tr> </thead> <tbody> <tr> <td>VI0515A0</td> <td>STAINLESS STEEL WASHER D=5 6592</td> <td>2.000</td> <td>PC</td> </tr> <tr> <td>VI1995A0</td> <td>M5x25 ST.STEEL SCREW</td> <td>2.000</td> <td>PC</td> </tr> <tr> <td>VM2458A0</td> <td>BL SP LATERAL DOOR LOW BRACKET COVER</td> <td>1.000</td> <td>PC</td> </tr> <tr> <td>VM2469A0</td> <td>BL SP LATERAL DOOR HOLDER BRACKET</td> <td>1.000</td> <td>PC</td> </tr> </tbody> </table>	Code	Description	Qty	UOM	VI0515A0	STAINLESS STEEL WASHER D=5 6592	2.000	PC	VI1995A0	M5x25 ST.STEEL SCREW	2.000	PC	VM2458A0	BL SP LATERAL DOOR LOW BRACKET COVER	1.000	PC	VM2469A0	BL SP LATERAL DOOR HOLDER BRACKET	1.000	PC
Code	Description	Qty	UOM																						
VI0515A0	STAINLESS STEEL WASHER D=5 6592	2.000	PC																						
VI1995A0	M5x25 ST.STEEL SCREW	2.000	PC																						
VM2458A0	BL SP LATERAL DOOR LOW BRACKET COVER	1.000	PC																						
VM2469A0	BL SP LATERAL DOOR HOLDER BRACKET	1.000	PC																						



COMPONENT			SPARE PART																						
Code	Description	Image	Code	Description	Kit components																				
VM2488A	BL SHOP.PRO MANUAL UNLOCK SYSTEM		KVM2488A	BL SHOP.PRO MANUAL UNLOCK SYSTEM KIT	<table border="1"> <thead> <tr> <th>Code</th> <th>Description</th> <th>Qty</th> <th>UOM</th> </tr> </thead> <tbody> <tr> <td>VI1220A1</td> <td>4,2x12 TCB SELF-TAPPIN G SCREW</td> <td>2.000</td> <td>PC</td> </tr> <tr> <td>VI1950A0</td> <td>ST. STEEL 4,2X13 TCB SELF-DRILLIN G SCREW</td> <td>2.000</td> <td>PC</td> </tr> <tr> <td>VM2488A1</td> <td>BL SHOP.PRO MANUAL UNLOCK SYSTEM</td> <td>1.000</td> <td>PC</td> </tr> <tr> <td>VM2501A0</td> <td>BL SHOP.PRO UNLOCK SCREW</td> <td>1.000</td> <td>PC</td> </tr> </tbody> </table>	Code	Description	Qty	UOM	VI1220A1	4,2x12 TCB SELF-TAPPIN G SCREW	2.000	PC	VI1950A0	ST. STEEL 4,2X13 TCB SELF-DRILLIN G SCREW	2.000	PC	VM2488A1	BL SHOP.PRO MANUAL UNLOCK SYSTEM	1.000	PC	VM2501A0	BL SHOP.PRO UNLOCK SCREW	1.000	PC
Code	Description	Qty	UOM																						
VI1220A1	4,2x12 TCB SELF-TAPPIN G SCREW	2.000	PC																						
VI1950A0	ST. STEEL 4,2X13 TCB SELF-DRILLIN G SCREW	2.000	PC																						
VM2488A1	BL SHOP.PRO MANUAL UNLOCK SYSTEM	1.000	PC																						
VM2501A0	BL SHOP.PRO UNLOCK SCREW	1.000	PC																						
VM1631A	PLUS INNER GLASS PUSHING CAP		KVM1631A	CAP FOR INTERNAL GLASS 10 PCS KIT	<table border="1"> <thead> <tr> <th>Code</th> <th>Description</th> <th>Qty</th> <th>UOM</th> </tr> </thead> <tbody> <tr> <td>VM1631A0</td> <td>PLUS INNER GLASS PUSHING CAP</td> <td>10.000</td> <td>PC</td> </tr> </tbody> </table>	Code	Description	Qty	UOM	VM1631A0	PLUS INNER GLASS PUSHING CAP	10.000	PC												
Code	Description	Qty	UOM																						
VM1631A0	PLUS INNER GLASS PUSHING CAP	10.000	PC																						
VM2490A	460X330 SP EXT FRONT BOTTOM GASKET		KVM2490A	SP 460X330 EXT BOTTOM PANEL GASKET KIT	<table border="1"> <thead> <tr> <th>Code</th> <th>Description</th> <th>Qty</th> <th>UOM</th> </tr> </thead> <tbody> <tr> <td>VM2490A0</td> <td>460X330 SP EXT FRONT BOTTOM GASKET</td> <td>2.000</td> <td>PC</td> </tr> </tbody> </table>	Code	Description	Qty	UOM	VM2490A0	460X330 SP EXT FRONT BOTTOM GASKET	2.000	PC												
Code	Description	Qty	UOM																						
VM2490A0	460X330 SP EXT FRONT BOTTOM GASKET	2.000	PC																						
VM2491A	460x330 BLSP LATERAL BOTTOM PANEL GASKET		KVM2491A	SP 460X330 LAT BOTT PANEL GASKET 2PC KIT	<table border="1"> <thead> <tr> <th>Code</th> <th>Description</th> <th>Qty</th> <th>UOM</th> </tr> </thead> <tbody> <tr> <td>VM1631A0</td> <td>PLUS INNER GLASS PUSHING CAP</td> <td>4.000</td> <td>PC</td> </tr> <tr> <td>VM2491A1</td> <td>460x330 BLSP LATERAL BOTTOM PANEL GASKE</td> <td>2.000</td> <td>PC</td> </tr> </tbody> </table>	Code	Description	Qty	UOM	VM1631A0	PLUS INNER GLASS PUSHING CAP	4.000	PC	VM2491A1	460x330 BLSP LATERAL BOTTOM PANEL GASKE	2.000	PC								
Code	Description	Qty	UOM																						
VM1631A0	PLUS INNER GLASS PUSHING CAP	4.000	PC																						
VM2491A1	460x330 BLSP LATERAL BOTTOM PANEL GASKE	2.000	PC																						



COMPONENT			SPARE PART										
Code	Description	Image	Code	Description	Kit components								
VM1222A	CABLE LOCKS SP ACCESSORIES EL CONNECTION		VM1222A0	CABLE LOCKS SP ACCESSORIES EL CONNECTION									
VM2249A	COOKING CHAMBER FRONT CORNER		KVM2249A	CHAMBER FRONT PROFILE CORNER KIT	<table border="1"> <thead> <tr> <th>Code</th> <th>Description</th> <th>Qty</th> <th>UOM</th> </tr> </thead> <tbody> <tr> <td>VM2249A0</td> <td>COOKING CHAMBER FRONT CORNER</td> <td>1.000</td> <td>PC</td> </tr> </tbody> </table>	Code	Description	Qty	UOM	VM2249A0	COOKING CHAMBER FRONT CORNER	1.000	PC
Code	Description	Qty	UOM										
VM2249A0	COOKING CHAMBER FRONT CORNER	1.000	PC										

ASM3426B/0.D01 - Door - FRONT

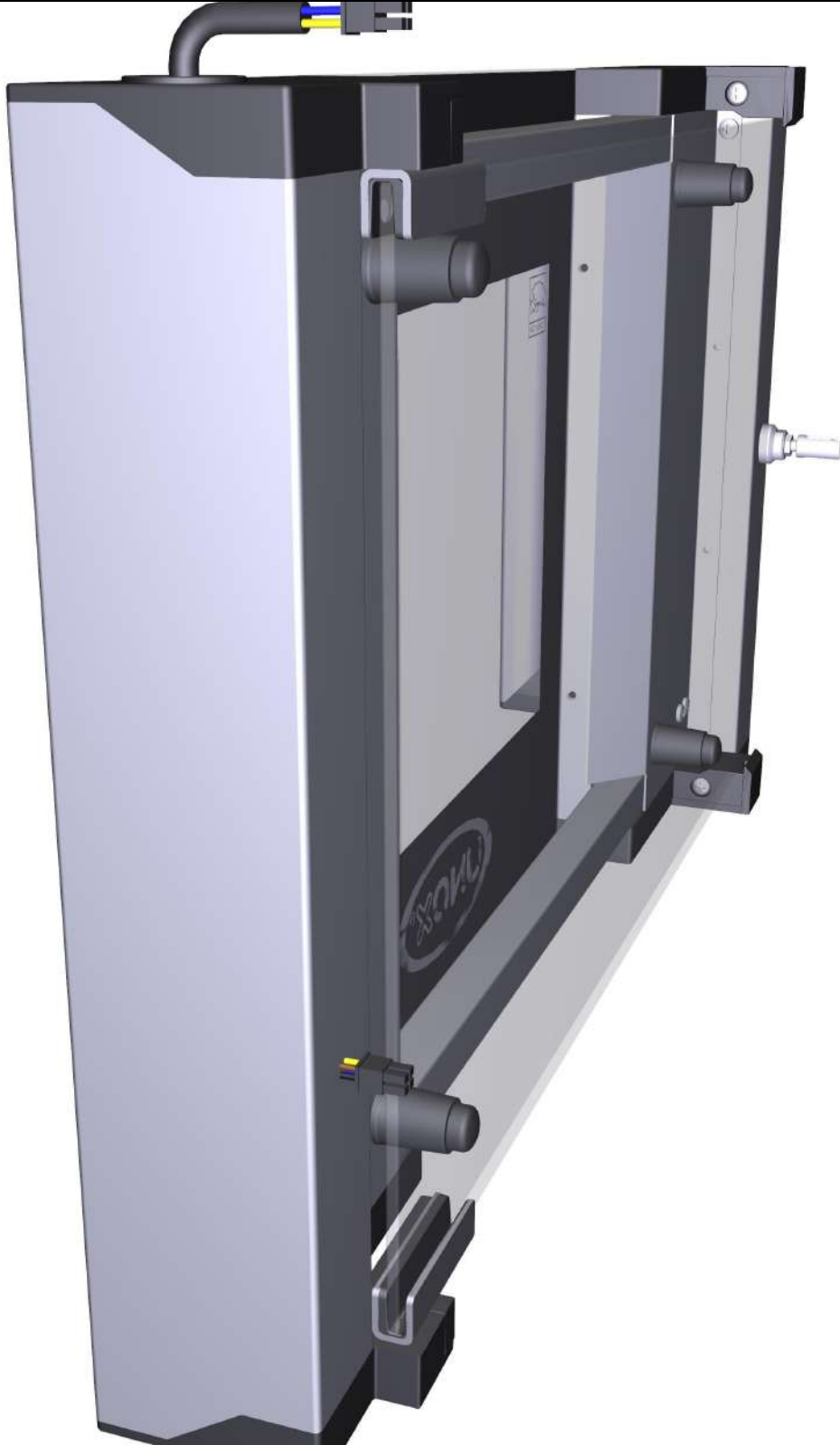

ASM3426B/0.D01 - Door - REAR





COMPONENT			SPARE PART																		
Code	Description	Image	Code	Description	Kit components																
0B1293A	SP STE-ELE RIGHT DOOR LEFT EXT COLUMN		0B1293A0	SP STE-ELE RIGHT DOOR LEFT EXT COLUMN																	
0B1294A	SP STE-ELE RIGHT DOOR LEFT INT COLUMN		0B1294A0	SP STE-ELE RIGHT DOOR LEFT INT COLUMN																	
0B1295B	SP STE-ELE RIGHT DOOR RIGHT EXT COLUMN		0B1295B0	SP STE-ELE RIGHT DOOR RIGHT EXT COLUMN																	
0B1296B	SP STE-ELE RIGHT DOOR RIGHT INT COLUMN		0B1296B0	SP STE-ELE RIGHT DOOR RIGHT INT COLUMN																	
LP1050A	BL SHOP.PRO L180 COMPLETE LED BA		KLP1050A	L180 COMPLETE LED LIGHT BAR KIT	<table border="1"> <thead> <tr> <th>Code</th> <th>Description</th> <th>Qty</th> <th>UOM</th> </tr> </thead> <tbody> <tr> <td>LP1050A0</td> <td>BL SHOP.PRO L180 COMPLETE LED BAR</td> <td>1.000</td> <td>PC</td> </tr> <tr> <td>VI1014A0</td> <td>STAINLESS STEEL WASHER 4.5X9X0.8</td> <td>1.000</td> <td>PC</td> </tr> <tr> <td>VI1220A1</td> <td>4,2x12 TCB SELF-TAPPIN G SCREW</td> <td>1.000</td> <td>PC</td> </tr> </tbody> </table>	Code	Description	Qty	UOM	LP1050A0	BL SHOP.PRO L180 COMPLETE LED BAR	1.000	PC	VI1014A0	STAINLESS STEEL WASHER 4.5X9X0.8	1.000	PC	VI1220A1	4,2x12 TCB SELF-TAPPIN G SCREW	1.000	PC
Code	Description	Qty	UOM																		
LP1050A0	BL SHOP.PRO L180 COMPLETE LED BAR	1.000	PC																		
VI1014A0	STAINLESS STEEL WASHER 4.5X9X0.8	1.000	PC																		
VI1220A1	4,2x12 TCB SELF-TAPPIN G SCREW	1.000	PC																		



COMPONENT			SPARE PART																										
Code	Description	Image	Code	Description	Kit components																								
TB3303A	SHOP.PRO STE-ELE FLAG DOOR HANDLE TUBE		KTB3303A	BL SP STE-ELE LATER DOOR HANDLE TUBE KIT	<table border="1"> <thead> <tr> <th>Code</th> <th>Description</th> <th>Qty</th> <th>UOM</th> </tr> </thead> <tbody> <tr> <td>TB3303A0</td> <td>SHOP.PRO STE-ELE FLAG DOOR HANDLE TUBE</td> <td>1.000</td> <td>PC</td> </tr> <tr> <td>VI1147A0</td> <td>5X25 STAINLESS STEEL SCREW</td> <td>4.000</td> <td>PC</td> </tr> <tr> <td>VM2456A0</td> <td>BAKERLUX SHOP.PRO HANDLE END</td> <td>1.000</td> <td>PC</td> </tr> <tr> <td>VM2489A0</td> <td>SP HANDLE END KIT + STYLUS KIT</td> <td>1.000</td> <td>PC</td> </tr> <tr> <td>VM2527A1</td> <td>EVEREO-S.Pro DISPLAY STYLUS</td> <td>1.000</td> <td>PC</td> </tr> </tbody> </table>	Code	Description	Qty	UOM	TB3303A0	SHOP.PRO STE-ELE FLAG DOOR HANDLE TUBE	1.000	PC	VI1147A0	5X25 STAINLESS STEEL SCREW	4.000	PC	VM2456A0	BAKERLUX SHOP.PRO HANDLE END	1.000	PC	VM2489A0	SP HANDLE END KIT + STYLUS KIT	1.000	PC	VM2527A1	EVEREO-S.Pro DISPLAY STYLUS	1.000	PC
					Code	Description	Qty	UOM																					
					TB3303A0	SHOP.PRO STE-ELE FLAG DOOR HANDLE TUBE	1.000	PC																					
					VI1147A0	5X25 STAINLESS STEEL SCREW	4.000	PC																					
					VM2456A0	BAKERLUX SHOP.PRO HANDLE END	1.000	PC																					
VM2489A0	SP HANDLE END KIT + STYLUS KIT	1.000	PC																										
VM2527A1	EVEREO-S.Pro DISPLAY STYLUS	1.000	PC																										
VM2456A	BAKERLUX SHOP.PRO HANDLE END		KVM2456A	2 PCS BAKERLUX SHOP.PRO HANDLE END KIT	<table border="1"> <thead> <tr> <th>Code</th> <th>Description</th> <th>Qty</th> <th>UOM</th> </tr> </thead> <tbody> <tr> <td>VI1147A0</td> <td>5X25 STAINLESS STEEL SCREW</td> <td>4.000</td> <td>PC</td> </tr> <tr> <td>VM2456A0</td> <td>BAKERLUX SHOP.PRO HANDLE END</td> <td>1.000</td> <td>PC</td> </tr> <tr> <td>VM2489A0</td> <td>SP HANDLE END KIT + STYLUS KIT</td> <td>1.000</td> <td>PC</td> </tr> <tr> <td>VM2527A1</td> <td>EVEREO-S.Pro DISPLAY STYLUS</td> <td>1.000</td> <td>PC</td> </tr> </tbody> </table>	Code	Description	Qty	UOM	VI1147A0	5X25 STAINLESS STEEL SCREW	4.000	PC	VM2456A0	BAKERLUX SHOP.PRO HANDLE END	1.000	PC	VM2489A0	SP HANDLE END KIT + STYLUS KIT	1.000	PC	VM2527A1	EVEREO-S.Pro DISPLAY STYLUS	1.000	PC				
					Code	Description	Qty	UOM																					
					VI1147A0	5X25 STAINLESS STEEL SCREW	4.000	PC																					
					VM2456A0	BAKERLUX SHOP.PRO HANDLE END	1.000	PC																					
VM2489A0	SP HANDLE END KIT + STYLUS KIT	1.000	PC																										
VM2527A1	EVEREO-S.Pro DISPLAY STYLUS	1.000	PC																										
VM2527A	EVEREO-S.Pro DISPLAY STYLUS		KVM2527A	EVEREO-S.Pro TOUCH STYLUS 5 PCS KIT	<table border="1"> <thead> <tr> <th>Code</th> <th>Description</th> <th>Qty</th> <th>UOM</th> </tr> </thead> <tbody> <tr> <td>VM2527A1</td> <td>EVEREO-S.Pro DISPLAY STYLUS</td> <td>5.000</td> <td>PC</td> </tr> </tbody> </table>	Code	Description	Qty	UOM	VM2527A1	EVEREO-S.Pro DISPLAY STYLUS	5.000	PC																
Code	Description	Qty	UOM																										
VM2527A1	EVEREO-S.Pro DISPLAY STYLUS	5.000	PC																										
VI1174A	VI1174A0		VI1174A0	VI1174A0																									







COMPONENT			SPARE PART																		
Code	Description	Image	Code	Description	Kit components																
VM2468A	BL SP LEFT UPPER LATERAL DOOR CA		KVM2468A	BL SP LEFT UPPER LATERAL DOOR CAP KIT	<table border="1"> <thead> <tr> <th>Code</th> <th>Description</th> <th>Qty</th> <th>UOM</th> </tr> </thead> <tbody> <tr> <td>VM2468A0</td> <td>BL SP LEFT UPPER LATERAL DOOR CAP</td> <td>1.000</td> <td>PC</td> </tr> </tbody> </table>	Code	Description	Qty	UOM	VM2468A0	BL SP LEFT UPPER LATERAL DOOR CAP	1.000	PC								
Code	Description	Qty	UOM																		
VM2468A0	BL SP LEFT UPPER LATERAL DOOR CAP	1.000	PC																		
VM2474A	BL SP INT GLASS HINGE UPPER LOCK PIN		KVM2474A	BL SP INT GLASS HINGE UPPER LOCK PIN KIT	<table border="1"> <thead> <tr> <th>Code</th> <th>Description</th> <th>Qty</th> <th>UOM</th> </tr> </thead> <tbody> <tr> <td>VM2474A0</td> <td>BL SP INT GLASS HINGE UPPER LOCK PIN</td> <td>1.000</td> <td>PC</td> </tr> </tbody> </table>	Code	Description	Qty	UOM	VM2474A0	BL SP INT GLASS HINGE UPPER LOCK PIN	1.000	PC								
Code	Description	Qty	UOM																		
VM2474A0	BL SP INT GLASS HINGE UPPER LOCK PIN	1.000	PC																		
ML1005A	DE5 DF0.6 H18 COMPRESSION SPRING		KVM2470A	BL SHOP.PRO INTERNAL GLASS LOCK 2PCS KIT	<table border="1"> <thead> <tr> <th>Code</th> <th>Description</th> <th>Qty</th> <th>UOM</th> </tr> </thead> <tbody> <tr> <td>ML1005A0</td> <td>DE5 DF0.6 H18 COMPRESSION SPRING</td> <td>2.000</td> <td>PC</td> </tr> <tr> <td>VM2470A0</td> <td>SLIDE TO FIX INTERNAL GLASS SHOP.PRO</td> <td>2.000</td> <td>PC</td> </tr> <tr> <td>VM2504A0</td> <td>DOWEL TO GUIDE SLIDE SPRING SHOP.PRO</td> <td>2.000</td> <td>PC</td> </tr> </tbody> </table>	Code	Description	Qty	UOM	ML1005A0	DE5 DF0.6 H18 COMPRESSION SPRING	2.000	PC	VM2470A0	SLIDE TO FIX INTERNAL GLASS SHOP.PRO	2.000	PC	VM2504A0	DOWEL TO GUIDE SLIDE SPRING SHOP.PRO	2.000	PC
Code	Description	Qty	UOM																		
ML1005A0	DE5 DF0.6 H18 COMPRESSION SPRING	2.000	PC																		
VM2470A0	SLIDE TO FIX INTERNAL GLASS SHOP.PRO	2.000	PC																		
VM2504A0	DOWEL TO GUIDE SLIDE SPRING SHOP.PRO	2.000	PC																		
VM2470A	SLIDE TO FIX INTERNAL GLASS SHOP.PRO		KVM2470A	BL SHOP.PRO INTERNAL GLASS LOCK 2PCS KIT	<table border="1"> <thead> <tr> <th>Code</th> <th>Description</th> <th>Qty</th> <th>UOM</th> </tr> </thead> <tbody> <tr> <td>ML1005A0</td> <td>DE5 DF0.6 H18 COMPRESSION SPRING</td> <td>2.000</td> <td>PC</td> </tr> <tr> <td>VM2470A0</td> <td>SLIDE TO FIX INTERNAL GLASS SHOP.PRO</td> <td>2.000</td> <td>PC</td> </tr> <tr> <td>VM2504A0</td> <td>DOWEL TO GUIDE SLIDE SPRING SHOP.PRO</td> <td>2.000</td> <td>PC</td> </tr> </tbody> </table>	Code	Description	Qty	UOM	ML1005A0	DE5 DF0.6 H18 COMPRESSION SPRING	2.000	PC	VM2470A0	SLIDE TO FIX INTERNAL GLASS SHOP.PRO	2.000	PC	VM2504A0	DOWEL TO GUIDE SLIDE SPRING SHOP.PRO	2.000	PC
Code	Description	Qty	UOM																		
ML1005A0	DE5 DF0.6 H18 COMPRESSION SPRING	2.000	PC																		
VM2470A0	SLIDE TO FIX INTERNAL GLASS SHOP.PRO	2.000	PC																		
VM2504A0	DOWEL TO GUIDE SLIDE SPRING SHOP.PRO	2.000	PC																		



COMPONENT			SPARE PART																		
Code	Description	Image	Code	Description	Kit components																
VM2472A	BL SP UPPER CLAMP INT LOCK GLASS SLIDER		KVM2471A	BL SP INTERNAL GLASS LOCK HOLDER KIT	<table border="1"> <thead> <tr> <th>Code</th> <th>Description</th> <th>Qty</th> <th>UOM</th> </tr> </thead> <tbody> <tr> <td>V11998A0</td> <td>ZINC PLATED SCREW 5X30 TCB</td> <td>2.000</td> <td>PC</td> </tr> <tr> <td>VM2471A0</td> <td>BL SP LOWER CLAMP INT LOCK GLASS SLIDER</td> <td>1.000</td> <td>PC</td> </tr> <tr> <td>VM2472A0</td> <td>BL SP UPPER CLAMP INT LOCK GLASS SLIDER</td> <td>1.000</td> <td>PC</td> </tr> </tbody> </table>	Code	Description	Qty	UOM	V11998A0	ZINC PLATED SCREW 5X30 TCB	2.000	PC	VM2471A0	BL SP LOWER CLAMP INT LOCK GLASS SLIDER	1.000	PC	VM2472A0	BL SP UPPER CLAMP INT LOCK GLASS SLIDER	1.000	PC
Code	Description	Qty	UOM																		
V11998A0	ZINC PLATED SCREW 5X30 TCB	2.000	PC																		
VM2471A0	BL SP LOWER CLAMP INT LOCK GLASS SLIDER	1.000	PC																		
VM2472A0	BL SP UPPER CLAMP INT LOCK GLASS SLIDER	1.000	PC																		
VM2504A	DOWEL TO GUIDE SLIDE SPRING SHOP.PRO		KVM2470A	BL SHOP.PRO INTERNAL GLASS LOCK 2PCS KIT	<table border="1"> <thead> <tr> <th>Code</th> <th>Description</th> <th>Qty</th> <th>UOM</th> </tr> </thead> <tbody> <tr> <td>ML1005A0</td> <td>DES DF0.6 H18 COMPRESSIO N SPRING</td> <td>2.000</td> <td>PC</td> </tr> <tr> <td>VM2470A0</td> <td>SLIDE TO FIX INTERNAL GLASS SHOP.PRO</td> <td>2.000</td> <td>PC</td> </tr> <tr> <td>VM2504A0</td> <td>DOWEL TO GUIDE SLIDE SPRING SHOP.PRO</td> <td>2.000</td> <td>PC</td> </tr> </tbody> </table>	Code	Description	Qty	UOM	ML1005A0	DES DF0.6 H18 COMPRESSIO N SPRING	2.000	PC	VM2470A0	SLIDE TO FIX INTERNAL GLASS SHOP.PRO	2.000	PC	VM2504A0	DOWEL TO GUIDE SLIDE SPRING SHOP.PRO	2.000	PC
Code	Description	Qty	UOM																		
ML1005A0	DES DF0.6 H18 COMPRESSIO N SPRING	2.000	PC																		
VM2470A0	SLIDE TO FIX INTERNAL GLASS SHOP.PRO	2.000	PC																		
VM2504A0	DOWEL TO GUIDE SLIDE SPRING SHOP.PRO	2.000	PC																		
VM2467A	SP SIDE-OPENING DOOR RIGHT UPPER CAP KIT		KVM2467A	BL SP RIGHT UPPER LATERAL DOOR CAP KIT	<table border="1"> <thead> <tr> <th>Code</th> <th>Description</th> <th>Qty</th> <th>UOM</th> </tr> </thead> <tbody> <tr> <td>VM2467A0</td> <td>SP SIDE-OPENIN G DOOR RIGHT UPPER CAP KIT</td> <td>1.000</td> <td>PC</td> </tr> </tbody> </table>	Code	Description	Qty	UOM	VM2467A0	SP SIDE-OPENIN G DOOR RIGHT UPPER CAP KIT	1.000	PC								
Code	Description	Qty	UOM																		
VM2467A0	SP SIDE-OPENIN G DOOR RIGHT UPPER CAP KIT	1.000	PC																		
TB1562A	DOOR LATERAL BEAM SP600		TB1562A0	DOOR LATERAL BEAM SP600																	







COMPONENT			SPARE PART																		
Code	Description	Image	Code	Description	Kit components																
VI1174A	VI1174A0		VI1174A0	VI1174A0																	
VI1174A	VI1174A0		VI1174A0	VI1174A0																	
VM2466A	BL SP LEFT LOWER LATERAL DOOR CA		KVM2466A	BL SP LEFT LOWER LATERAL DOOR CAP KIT	<table border="1"> <thead> <tr> <th>Code</th> <th>Description</th> <th>Qty</th> <th>UOM</th> </tr> </thead> <tbody> <tr> <td>VM2466A0</td> <td>BL SP LEFT LOWER LATERAL DOOR CAP</td> <td>1.000</td> <td>PC</td> </tr> </tbody> </table>	Code	Description	Qty	UOM	VM2466A0	BL SP LEFT LOWER LATERAL DOOR CAP	1.000	PC								
Code	Description	Qty	UOM																		
VM2466A0	BL SP LEFT LOWER LATERAL DOOR CAP	1.000	PC																		
VM2473A	BL SP INT GLASS HINGE LOWER LOCK PIN		KVM2473A	BL SP INT GLASS HINGE LOWER LOCK PIN KIT	<table border="1"> <thead> <tr> <th>Code</th> <th>Description</th> <th>Qty</th> <th>UOM</th> </tr> </thead> <tbody> <tr> <td>VM2473A0</td> <td>BL SP INT GLASS HINGE LOWER LOCK PIN</td> <td>1.000</td> <td>PC</td> </tr> </tbody> </table>	Code	Description	Qty	UOM	VM2473A0	BL SP INT GLASS HINGE LOWER LOCK PIN	1.000	PC								
Code	Description	Qty	UOM																		
VM2473A0	BL SP INT GLASS HINGE LOWER LOCK PIN	1.000	PC																		
ML1005A	DE5 DF0.6 H18 COMPRESSION SPRING		KVM2470A	BL SHOP.PRO INTERNAL GLASS LOCK 2PCS KIT	<table border="1"> <thead> <tr> <th>Code</th> <th>Description</th> <th>Qty</th> <th>UOM</th> </tr> </thead> <tbody> <tr> <td>ML1005A0</td> <td>DE5 DF0.6 H18 COMPRESSION SPRING</td> <td>2.000</td> <td>PC</td> </tr> <tr> <td>VM2470A0</td> <td>SLIDE TO FIX INTERNAL GLASS SHOP.PRO</td> <td>2.000</td> <td>PC</td> </tr> <tr> <td>VM2504A0</td> <td>DOWEL TO GUIDE SLIDE SPRING SHOP.PRO</td> <td>2.000</td> <td>PC</td> </tr> </tbody> </table>	Code	Description	Qty	UOM	ML1005A0	DE5 DF0.6 H18 COMPRESSION SPRING	2.000	PC	VM2470A0	SLIDE TO FIX INTERNAL GLASS SHOP.PRO	2.000	PC	VM2504A0	DOWEL TO GUIDE SLIDE SPRING SHOP.PRO	2.000	PC
Code	Description	Qty	UOM																		
ML1005A0	DE5 DF0.6 H18 COMPRESSION SPRING	2.000	PC																		
VM2470A0	SLIDE TO FIX INTERNAL GLASS SHOP.PRO	2.000	PC																		
VM2504A0	DOWEL TO GUIDE SLIDE SPRING SHOP.PRO	2.000	PC																		



COMPONENT			SPARE PART																		
Code	Description	Image	Code	Description	Kit components																
VM2470A	SLIDE TO FIX INTERNAL GLASS SHOP.PRO		KVM2470A	BL SHOP.PRO INTERNAL GLASS LOCK 2PCS KIT	<table border="1"> <thead> <tr> <th>Code</th> <th>Description</th> <th>Qty</th> <th>UOM</th> </tr> </thead> <tbody> <tr> <td>ML1005A0</td> <td>DES DF0.6 H18 COMPRESSIO N SPRING</td> <td>2.000</td> <td>PC</td> </tr> <tr> <td>VM2470A0</td> <td>SLIDE TO FIX INTERNAL GLASS SHOP.PRO</td> <td>2.000</td> <td>PC</td> </tr> <tr> <td>VM2504A0</td> <td>DOWEL TO GUIDE SLIDE SPRING SHOP.PRO</td> <td>2.000</td> <td>PC</td> </tr> </tbody> </table>	Code	Description	Qty	UOM	ML1005A0	DES DF0.6 H18 COMPRESSIO N SPRING	2.000	PC	VM2470A0	SLIDE TO FIX INTERNAL GLASS SHOP.PRO	2.000	PC	VM2504A0	DOWEL TO GUIDE SLIDE SPRING SHOP.PRO	2.000	PC
					Code	Description	Qty	UOM													
					ML1005A0	DES DF0.6 H18 COMPRESSIO N SPRING	2.000	PC													
VM2470A0	SLIDE TO FIX INTERNAL GLASS SHOP.PRO	2.000	PC																		
VM2504A0	DOWEL TO GUIDE SLIDE SPRING SHOP.PRO	2.000	PC																		
<table border="1"> <thead> <tr> <th>Code</th> <th>Description</th> <th>Qty</th> <th>UOM</th> </tr> </thead> <tbody> <tr> <td>VH1998A0</td> <td>ZINC PLATED SCREW 5X30 TCB</td> <td>2.000</td> <td>PC</td> </tr> <tr> <td>VM2471A0</td> <td>BL SP LOWER CLAMP INT LOCK GLASS SLIDER</td> <td>1.000</td> <td>PC</td> </tr> <tr> <td>VM2472A0</td> <td>BL SP UPPER CLAMP INT LOCK GLASS SLIDER</td> <td>1.000</td> <td>PC</td> </tr> </tbody> </table>	Code	Description	Qty	UOM	VH1998A0	ZINC PLATED SCREW 5X30 TCB	2.000	PC	VM2471A0	BL SP LOWER CLAMP INT LOCK GLASS SLIDER	1.000	PC	VM2472A0	BL SP UPPER CLAMP INT LOCK GLASS SLIDER	1.000	PC					
Code	Description	Qty	UOM																		
VH1998A0	ZINC PLATED SCREW 5X30 TCB	2.000	PC																		
VM2471A0	BL SP LOWER CLAMP INT LOCK GLASS SLIDER	1.000	PC																		
VM2472A0	BL SP UPPER CLAMP INT LOCK GLASS SLIDER	1.000	PC																		
<table border="1"> <thead> <tr> <th>Code</th> <th>Description</th> <th>Qty</th> <th>UOM</th> </tr> </thead> <tbody> <tr> <td>ML1005A0</td> <td>DES DF0.6 H18 COMPRESSIO N SPRING</td> <td>2.000</td> <td>PC</td> </tr> <tr> <td>VM2470A0</td> <td>SLIDE TO FIX INTERNAL GLASS SHOP.PRO</td> <td>2.000</td> <td>PC</td> </tr> <tr> <td>VM2504A0</td> <td>DOWEL TO GUIDE SLIDE SPRING SHOP.PRO</td> <td>2.000</td> <td>PC</td> </tr> </tbody> </table>	Code	Description	Qty	UOM	ML1005A0	DES DF0.6 H18 COMPRESSIO N SPRING	2.000	PC	VM2470A0	SLIDE TO FIX INTERNAL GLASS SHOP.PRO	2.000	PC	VM2504A0	DOWEL TO GUIDE SLIDE SPRING SHOP.PRO	2.000	PC					
Code	Description	Qty	UOM																		
ML1005A0	DES DF0.6 H18 COMPRESSIO N SPRING	2.000	PC																		
VM2470A0	SLIDE TO FIX INTERNAL GLASS SHOP.PRO	2.000	PC																		
VM2504A0	DOWEL TO GUIDE SLIDE SPRING SHOP.PRO	2.000	PC																		
VM2471A	BL SP LOWER CLAMP INT LOCK GLASS SLIDER		KVM2471A	BL SP INTERNAL GLASS LOCK HOLDER KIT	<table border="1"> <thead> <tr> <th>Code</th> <th>Description</th> <th>Qty</th> <th>UOM</th> </tr> </thead> <tbody> <tr> <td>VH1998A0</td> <td>ZINC PLATED SCREW 5X30 TCB</td> <td>2.000</td> <td>PC</td> </tr> <tr> <td>VM2471A0</td> <td>BL SP LOWER CLAMP INT LOCK GLASS SLIDER</td> <td>1.000</td> <td>PC</td> </tr> <tr> <td>VM2472A0</td> <td>BL SP UPPER CLAMP INT LOCK GLASS SLIDER</td> <td>1.000</td> <td>PC</td> </tr> </tbody> </table>	Code	Description	Qty	UOM	VH1998A0	ZINC PLATED SCREW 5X30 TCB	2.000	PC	VM2471A0	BL SP LOWER CLAMP INT LOCK GLASS SLIDER	1.000	PC	VM2472A0	BL SP UPPER CLAMP INT LOCK GLASS SLIDER	1.000	PC
Code	Description	Qty	UOM																		
VH1998A0	ZINC PLATED SCREW 5X30 TCB	2.000	PC																		
VM2471A0	BL SP LOWER CLAMP INT LOCK GLASS SLIDER	1.000	PC																		
VM2472A0	BL SP UPPER CLAMP INT LOCK GLASS SLIDER	1.000	PC																		
VM2504A	DOWEL TO GUIDE SLIDE SPRING SHOP.PRO		KVM2470A	BL SHOP.PRO INTERNAL GLASS LOCK 2PCS KIT	<table border="1"> <thead> <tr> <th>Code</th> <th>Description</th> <th>Qty</th> <th>UOM</th> </tr> </thead> <tbody> <tr> <td>ML1005A0</td> <td>DES DF0.6 H18 COMPRESSIO N SPRING</td> <td>2.000</td> <td>PC</td> </tr> <tr> <td>VM2470A0</td> <td>SLIDE TO FIX INTERNAL GLASS SHOP.PRO</td> <td>2.000</td> <td>PC</td> </tr> <tr> <td>VM2504A0</td> <td>DOWEL TO GUIDE SLIDE SPRING SHOP.PRO</td> <td>2.000</td> <td>PC</td> </tr> </tbody> </table>	Code	Description	Qty	UOM	ML1005A0	DES DF0.6 H18 COMPRESSIO N SPRING	2.000	PC	VM2470A0	SLIDE TO FIX INTERNAL GLASS SHOP.PRO	2.000	PC	VM2504A0	DOWEL TO GUIDE SLIDE SPRING SHOP.PRO	2.000	PC
Code	Description	Qty	UOM																		
ML1005A0	DES DF0.6 H18 COMPRESSIO N SPRING	2.000	PC																		
VM2470A0	SLIDE TO FIX INTERNAL GLASS SHOP.PRO	2.000	PC																		
VM2504A0	DOWEL TO GUIDE SLIDE SPRING SHOP.PRO	2.000	PC																		
VM2465A	SP SIDE-OPENING DOOR RIGHT LOWER CAP KIT		KVM2465A	BL SP RIGHT LOWER LATERAL DOOR CAP KIT	<table border="1"> <thead> <tr> <th>Code</th> <th>Description</th> <th>Qty</th> <th>UOM</th> </tr> </thead> <tbody> <tr> <td>VM2465A0</td> <td>SP SIDE-OPENIN G DOOR RIGHT LOWER CAP KIT</td> <td>1.000</td> <td>PC</td> </tr> </tbody> </table>	Code	Description	Qty	UOM	VM2465A0	SP SIDE-OPENIN G DOOR RIGHT LOWER CAP KIT	1.000	PC								
Code	Description	Qty	UOM																		
VM2465A0	SP SIDE-OPENIN G DOOR RIGHT LOWER CAP KIT	1.000	PC																		



COMPONENT			SPARE PART														
Code	Description	Image	Code	Description	Kit components												
TB1562A	DOOR LATERAL BEAM SP600		TB1562A0	DOOR LATERAL BEAM SP600													
VI1174A	VI1174A0		VI1174A0	VI1174A0													
VM1630A	INTERNAL GLASS PUSHING CAP		KVM1630A	CAP FOR INTERNAL GLASS 10 PCS KIT	<table border="1"> <thead> <tr> <th>Code</th> <th>Description</th> <th>Qty</th> <th>UOM</th> </tr> </thead> <tbody> <tr> <td>VM1630A1</td> <td>INTERNAL GLASS PUSHING CAP</td> <td>10.000</td> <td>PC</td> </tr> </tbody> </table>	Code	Description	Qty	UOM	VM1630A1	INTERNAL GLASS PUSHING CAP	10.000	PC				
Code	Description	Qty	UOM														
VM1630A1	INTERNAL GLASS PUSHING CAP	10.000	PC														
VM2478A	BL SP GLASS H4 PUSHING BRACKET		KVM2478A	BL SHOP.PRO H4 GLASS SUPPORT 4 PCS KIT	<table border="1"> <thead> <tr> <th>Code</th> <th>Description</th> <th>Qty</th> <th>UOM</th> </tr> </thead> <tbody> <tr> <td>VM1630A1</td> <td>INTERNAL GLASS PUSHING CAP</td> <td>4.000</td> <td>PC</td> </tr> <tr> <td>VM2478A0</td> <td>BL SP GLASS H4 PUSHING BRACKET</td> <td>4.000</td> <td>PC</td> </tr> </tbody> </table>	Code	Description	Qty	UOM	VM1630A1	INTERNAL GLASS PUSHING CAP	4.000	PC	VM2478A0	BL SP GLASS H4 PUSHING BRACKET	4.000	PC
Code	Description	Qty	UOM														
VM1630A1	INTERNAL GLASS PUSHING CAP	4.000	PC														
VM2478A0	BL SP GLASS H4 PUSHING BRACKET	4.000	PC														
CE1095A	4 POLES MICROFIT 2 M BUS CABLE		KCE1095A	4POLES 2M BUS CABLE KIT POWER-CONTROL	<table border="1"> <thead> <tr> <th>Code</th> <th>Description</th> <th>Qty</th> <th>UOM</th> </tr> </thead> <tbody> <tr> <td>CE1095A0</td> <td>4 POLES MICROFIT 2 M BUS CABLE</td> <td>1.000</td> <td>PC</td> </tr> </tbody> </table>	Code	Description	Qty	UOM	CE1095A0	4 POLES MICROFIT 2 M BUS CABLE	1.000	PC				
Code	Description	Qty	UOM														
CE1095A0	4 POLES MICROFIT 2 M BUS CABLE	1.000	PC														

COMPONENT			SPARE PART																										
Code	Description	Image	Code	Description	Kit components																								
CE1285A	EMI ROUND FERRITE MOD.2643801502		KCE1285A	ROUND FERRITE ELECTROMAGN PROT. 2PCS KIT	<table border="1"> <thead> <tr> <th>Code</th> <th>Description</th> <th>Qty</th> <th>UOM</th> </tr> </thead> <tbody> <tr> <td>CE1285A0</td> <td>EMI ROUND FERRITE MOD.2643801502</td> <td>2.000</td> <td>PC</td> </tr> </tbody> </table>	Code	Description	Qty	UOM	CE1285A0	EMI ROUND FERRITE MOD.2643801502	2.000	PC																
Code	Description	Qty	UOM																										
CE1285A0	EMI ROUND FERRITE MOD.2643801502	2.000	PC																										
CR1040A	DOOR LATCH FOR EL.MECH. LOCKING SYSTEM		KCR1040A	LM MATIC DOOR LOCKING PIN KIT	<table border="1"> <thead> <tr> <th>Code</th> <th>Description</th> <th>Qty</th> <th>UOM</th> </tr> </thead> <tbody> <tr> <td>0H10283A0</td> <td></td> <td>1.000</td> <td>PC</td> </tr> <tr> <td>CR1040A0</td> <td>DOOR LATCH FOR EL.MECH. LOCKING SYSTEM</td> <td>1.000</td> <td>PC</td> </tr> </tbody> </table>	Code	Description	Qty	UOM	0H10283A0		1.000	PC	CR1040A0	DOOR LATCH FOR EL.MECH. LOCKING SYSTEM	1.000	PC												
Code	Description	Qty	UOM																										
0H10283A0		1.000	PC																										
CR1040A0	DOOR LATCH FOR EL.MECH. LOCKING SYSTEM	1.000	PC																										
PE1443A	SP TOUCH CAPACITIVE CONTROL PANEL		KPE1443A	SP TOUCH CAPACITIVE CONTROL PANEL KI	<table border="1"> <thead> <tr> <th>Code</th> <th>Description</th> <th>Qty</th> <th>UOM</th> </tr> </thead> <tbody> <tr> <td>CE2112A0</td> <td></td> <td>1.000</td> <td>PC</td> </tr> <tr> <td>PE1443A0</td> <td>SP TOUCH CAPACITIVE CONTROL PANEL</td> <td>1.000</td> <td>PC</td> </tr> <tr> <td>VI1930A1</td> <td>5x20 ST. STEEL CHIP SCREW</td> <td>2.000</td> <td>PC</td> </tr> <tr> <td>VM1447A0</td> <td></td> <td>1.000</td> <td>PC</td> </tr> <tr> <td>VM2527A1</td> <td>EVEREO-S.Pro DISPLAY STYLUS</td> <td>1.000</td> <td>PC</td> </tr> </tbody> </table>	Code	Description	Qty	UOM	CE2112A0		1.000	PC	PE1443A0	SP TOUCH CAPACITIVE CONTROL PANEL	1.000	PC	VI1930A1	5x20 ST. STEEL CHIP SCREW	2.000	PC	VM1447A0		1.000	PC	VM2527A1	EVEREO-S.Pro DISPLAY STYLUS	1.000	PC
Code	Description	Qty	UOM																										
CE2112A0		1.000	PC																										
PE1443A0	SP TOUCH CAPACITIVE CONTROL PANEL	1.000	PC																										
VI1930A1	5x20 ST. STEEL CHIP SCREW	2.000	PC																										
VM1447A0		1.000	PC																										
VM2527A1	EVEREO-S.Pro DISPLAY STYLUS	1.000	PC																										
VI1174A	VI1174A0		VI1174A0	VI1174A0																									
VM1209A	SHOP.PRO LOCK PIN WASHER		KVM1209A	BAKERLUX SHOP.PRO PIN BUSHING LOCK KIT	<table border="1"> <thead> <tr> <th>Code</th> <th>Description</th> <th>Qty</th> <th>UOM</th> </tr> </thead> <tbody> <tr> <td>VM1209A0</td> <td>SHOP.PRO LOCK PIN WASHER</td> <td>1.000</td> <td>PC</td> </tr> </tbody> </table>	Code	Description	Qty	UOM	VM1209A0	SHOP.PRO LOCK PIN WASHER	1.000	PC																
Code	Description	Qty	UOM																										
VM1209A0	SHOP.PRO LOCK PIN WASHER	1.000	PC																										



COMPONENT			SPARE PART																																															
Code	Description	Image	Code	Description	Kit components																																													
VM2274A	GROOVED BUSHING		KVM2274A	GROOVED PIN BUSHING KIT	<table border="1"> <thead> <tr> <th>Code</th> <th>Description</th> <th>Qty</th> <th>UOM</th> </tr> </thead> <tbody> <tr> <td>VM2274A0</td> <td>GROOVED BUSHING</td> <td>1.000</td> <td>PC</td> </tr> </tbody> </table>	Code	Description	Qty	UOM	VM2274A0	GROOVED BUSHING	1.000	PC																																					
			Code	Description	Qty	UOM																																												
VM2274A0	GROOVED BUSHING	1.000	PC																																															
K0B1126AR	BAKERTOP MM RIGHT DOOR LOWER BEAM KIT	<table border="1"> <thead> <tr> <th>Code</th> <th>Description</th> <th>Qty</th> <th>UOM</th> </tr> </thead> <tbody> <tr> <td>0B1126A1</td> <td>860mm DOOR LOWER FRAME SHAPE</td> <td>1.000</td> <td>PC</td> </tr> <tr> <td>RC1200A0</td> <td>ED=4 WIRE D=0.5 H24 COMPRESSIO N SPRING</td> <td>2.000</td> <td>PC</td> </tr> <tr> <td>VI1220A1</td> <td>4,2x12 TCB SELF-TAPPIN G SCREW</td> <td>1.000</td> <td>PC</td> </tr> <tr> <td>VI1996A0</td> <td>M5x35 SCREW</td> <td>7.000</td> <td>PC</td> </tr> <tr> <td>VM1794A0</td> <td>250x4.8 PA66 BLACK CLAMP</td> <td>2.000</td> <td>PC</td> </tr> <tr> <td>VM2259A1</td> <td>6 SERIES DOOR LOWER LEFT CAP</td> <td>1.000</td> <td>PC</td> </tr> <tr> <td>VM2261A1</td> <td>MM DOOR LOWER RIGHT CAP</td> <td>1.000</td> <td>PC</td> </tr> <tr> <td>VM2267A1</td> <td>INNER GLASS LOCKING SYSTEM SLIDER</td> <td>1.000</td> <td>PC</td> </tr> <tr> <td>VM2269A0</td> <td>INTERNAL GLASS LOCKING SYSTEM CAP</td> <td>1.000</td> <td>PC</td> </tr> <tr> <td>VM2274A0</td> <td>GROOVED BUSHING</td> <td>1.000</td> <td>PC</td> </tr> <tr> <td>VM2305A0</td> <td>MM SERIES DOOR CAP FIXING PAWL</td> <td>7.000</td> <td>PC</td> </tr> </tbody> </table>	Code	Description	Qty	UOM	0B1126A1	860mm DOOR LOWER FRAME SHAPE	1.000	PC	RC1200A0	ED=4 WIRE D=0.5 H24 COMPRESSIO N SPRING	2.000	PC	VI1220A1	4,2x12 TCB SELF-TAPPIN G SCREW	1.000	PC	VI1996A0	M5x35 SCREW	7.000	PC	VM1794A0	250x4.8 PA66 BLACK CLAMP	2.000	PC	VM2259A1	6 SERIES DOOR LOWER LEFT CAP	1.000	PC	VM2261A1	MM DOOR LOWER RIGHT CAP	1.000	PC	VM2267A1	INNER GLASS LOCKING SYSTEM SLIDER	1.000	PC	VM2269A0	INTERNAL GLASS LOCKING SYSTEM CAP	1.000	PC	VM2274A0	GROOVED BUSHING	1.000	PC	VM2305A0	MM SERIES DOOR CAP FIXING PAWL	7.000	PC
Code	Description	Qty	UOM																																															
0B1126A1	860mm DOOR LOWER FRAME SHAPE	1.000	PC																																															
RC1200A0	ED=4 WIRE D=0.5 H24 COMPRESSIO N SPRING	2.000	PC																																															
VI1220A1	4,2x12 TCB SELF-TAPPIN G SCREW	1.000	PC																																															
VI1996A0	M5x35 SCREW	7.000	PC																																															
VM1794A0	250x4.8 PA66 BLACK CLAMP	2.000	PC																																															
VM2259A1	6 SERIES DOOR LOWER LEFT CAP	1.000	PC																																															
VM2261A1	MM DOOR LOWER RIGHT CAP	1.000	PC																																															
VM2267A1	INNER GLASS LOCKING SYSTEM SLIDER	1.000	PC																																															
VM2269A0	INTERNAL GLASS LOCKING SYSTEM CAP	1.000	PC																																															
VM2274A0	GROOVED BUSHING	1.000	PC																																															
VM2305A0	MM SERIES DOOR CAP FIXING PAWL	7.000	PC																																															
K0B1126AL	EU AND 2/1 MM LEFT DOOR LOWER BEAM KIT	<table border="1"> <thead> <tr> <th>Code</th> <th>Description</th> <th>Qty</th> <th>UOM</th> </tr> </thead> <tbody> <tr> <td>0B1126A1</td> <td>860mm DOOR LOWER FRAME SHAPE</td> <td>1.000</td> <td>PC</td> </tr> <tr> <td>RC1200A0</td> <td>ED=4 WIRE D=0.5 H24 COMPRESSIO N SPRING</td> <td>2.000</td> <td>PC</td> </tr> <tr> <td>VI1220A1</td> <td>4,2x12 TCB SELF-TAPPIN G SCREW</td> <td>1.000</td> <td>PC</td> </tr> <tr> <td>VI1996A0</td> <td>M5x35 SCREW</td> <td>7.000</td> <td>PC</td> </tr> <tr> <td>VM1794A0</td> <td>250x4.8 PA66 BLACK CLAMP</td> <td>2.000</td> <td>PC</td> </tr> <tr> <td>VM2267A1</td> <td>INNER GLASS LOCKING SYSTEM SLIDER</td> <td>1.000</td> <td>PC</td> </tr> </tbody> </table>	Code	Description	Qty	UOM	0B1126A1	860mm DOOR LOWER FRAME SHAPE	1.000	PC	RC1200A0	ED=4 WIRE D=0.5 H24 COMPRESSIO N SPRING	2.000	PC	VI1220A1	4,2x12 TCB SELF-TAPPIN G SCREW	1.000	PC	VI1996A0	M5x35 SCREW	7.000	PC	VM1794A0	250x4.8 PA66 BLACK CLAMP	2.000	PC	VM2267A1	INNER GLASS LOCKING SYSTEM SLIDER	1.000	PC																				
Code	Description	Qty	UOM																																															
0B1126A1	860mm DOOR LOWER FRAME SHAPE	1.000	PC																																															
RC1200A0	ED=4 WIRE D=0.5 H24 COMPRESSIO N SPRING	2.000	PC																																															
VI1220A1	4,2x12 TCB SELF-TAPPIN G SCREW	1.000	PC																																															
VI1996A0	M5x35 SCREW	7.000	PC																																															
VM1794A0	250x4.8 PA66 BLACK CLAMP	2.000	PC																																															
VM2267A1	INNER GLASS LOCKING SYSTEM SLIDER	1.000	PC																																															



COMPONENT			SPARE PART																																											
Code	Description	Image	Code	Description	Kit components																																									
VM2274A	GROOVED BUSHING		K0B1126AL	EU AND 2/1 MM LEFT DOOR LOWER BEAM KIT	<table border="1"> <thead> <tr> <th>Code</th> <th>Description</th> <th>Qty</th> <th>UOM</th> </tr> </thead> <tbody> <tr> <td>VM2269A0</td> <td>INTERNAL GLASS LOCKING SYSTEM CAP</td> <td>1.000</td> <td>PC</td> </tr> <tr> <td>VM2274A0</td> <td>GROOVED BUSHING</td> <td>1.000</td> <td>PC</td> </tr> <tr> <td>VM2305A0</td> <td>MM SERIES DOOR CAP FIXING PAWL</td> <td>7.000</td> <td>PC</td> </tr> <tr> <td>VM2384A0</td> <td>MM LEFT DOOR RIGHT LOWER CAP</td> <td>1.000</td> <td>PC</td> </tr> <tr> <td>VM2386A1</td> <td>LEFT MM DOOR LOWER LEFT CAP</td> <td>1.000</td> <td>PC</td> </tr> </tbody> </table>	Code	Description	Qty	UOM	VM2269A0	INTERNAL GLASS LOCKING SYSTEM CAP	1.000	PC	VM2274A0	GROOVED BUSHING	1.000	PC	VM2305A0	MM SERIES DOOR CAP FIXING PAWL	7.000	PC	VM2384A0	MM LEFT DOOR RIGHT LOWER CAP	1.000	PC	VM2386A1	LEFT MM DOOR LOWER LEFT CAP	1.000	PC																	
			Code	Description	Qty	UOM																																								
			VM2269A0	INTERNAL GLASS LOCKING SYSTEM CAP	1.000	PC																																								
VM2274A0	GROOVED BUSHING	1.000	PC																																											
VM2305A0	MM SERIES DOOR CAP FIXING PAWL	7.000	PC																																											
VM2384A0	MM LEFT DOOR RIGHT LOWER CAP	1.000	PC																																											
VM2386A1	LEFT MM DOOR LOWER LEFT CAP	1.000	PC																																											
K0B1122AR	CHEFTOP MM RIGHT DOOR LOWER BEAM KIT	<table border="1"> <thead> <tr> <th>Code</th> <th>Description</th> <th>Qty</th> <th>UOM</th> </tr> </thead> <tbody> <tr> <td>0B1122A1</td> <td>750MM DOOR LOWER FRAME SHAPE</td> <td>1.000</td> <td>PC</td> </tr> <tr> <td>RC1200A0</td> <td>ED=4 WIRE D=0.5 H24 COMPRESSIO N SPRING</td> <td>2.000</td> <td>PC</td> </tr> <tr> <td>VI1220A1</td> <td>4,2x12 TCB SELF-TAPPIN G SCREW</td> <td>1.000</td> <td>PC</td> </tr> <tr> <td>VI1996A0</td> <td>M5x35 SCREW</td> <td>7.000</td> <td>PC</td> </tr> <tr> <td>VM2259A1</td> <td>6 SERIES DOOR LOWER LEFT CAP</td> <td>1.000</td> <td>PC</td> </tr> <tr> <td>VM2261A1</td> <td>MM DOOR LOWER RIGHT CAP</td> <td>1.000</td> <td>PC</td> </tr> <tr> <td>VM2267A1</td> <td>INNER GLASS LOCKING SYSTEM SLIDER</td> <td>1.000</td> <td>PC</td> </tr> <tr> <td>VM2269A0</td> <td>INTERNAL GLASS LOCKING SYSTEM CAP</td> <td>1.000</td> <td>PC</td> </tr> <tr> <td>VM2274A0</td> <td>GROOVED BUSHING</td> <td>1.000</td> <td>PC</td> </tr> <tr> <td>VM2305A0</td> <td>MM SERIES DOOR CAP FIXING PAWL</td> <td>7.000</td> <td>PC</td> </tr> </tbody> </table>	Code	Description	Qty	UOM	0B1122A1	750MM DOOR LOWER FRAME SHAPE	1.000	PC	RC1200A0	ED=4 WIRE D=0.5 H24 COMPRESSIO N SPRING	2.000	PC	VI1220A1	4,2x12 TCB SELF-TAPPIN G SCREW	1.000	PC	VI1996A0	M5x35 SCREW	7.000	PC	VM2259A1	6 SERIES DOOR LOWER LEFT CAP	1.000	PC	VM2261A1	MM DOOR LOWER RIGHT CAP	1.000	PC	VM2267A1	INNER GLASS LOCKING SYSTEM SLIDER	1.000	PC	VM2269A0	INTERNAL GLASS LOCKING SYSTEM CAP	1.000	PC	VM2274A0	GROOVED BUSHING	1.000	PC	VM2305A0	MM SERIES DOOR CAP FIXING PAWL	7.000	PC
Code	Description	Qty	UOM																																											
0B1122A1	750MM DOOR LOWER FRAME SHAPE	1.000	PC																																											
RC1200A0	ED=4 WIRE D=0.5 H24 COMPRESSIO N SPRING	2.000	PC																																											
VI1220A1	4,2x12 TCB SELF-TAPPIN G SCREW	1.000	PC																																											
VI1996A0	M5x35 SCREW	7.000	PC																																											
VM2259A1	6 SERIES DOOR LOWER LEFT CAP	1.000	PC																																											
VM2261A1	MM DOOR LOWER RIGHT CAP	1.000	PC																																											
VM2267A1	INNER GLASS LOCKING SYSTEM SLIDER	1.000	PC																																											
VM2269A0	INTERNAL GLASS LOCKING SYSTEM CAP	1.000	PC																																											
VM2274A0	GROOVED BUSHING	1.000	PC																																											
VM2305A0	MM SERIES DOOR CAP FIXING PAWL	7.000	PC																																											
K0B1122AL	CHEFTOP MM LEFT DOOR LOWER BEAM KIT	<table border="1"> <thead> <tr> <th>Code</th> <th>Description</th> <th>Qty</th> <th>UOM</th> </tr> </thead> <tbody> <tr> <td>0B1122A1</td> <td>750MM DOOR LOWER FRAME SHAPE</td> <td>1.000</td> <td>PC</td> </tr> </tbody> </table>	Code	Description	Qty	UOM	0B1122A1	750MM DOOR LOWER FRAME SHAPE	1.000	PC																																				
Code	Description	Qty	UOM																																											
0B1122A1	750MM DOOR LOWER FRAME SHAPE	1.000	PC																																											



COMPONENT			SPARE PART																																														
Code	Description	Image	Code	Description	Kit components																																												
VM2274A	GROOVED BUSHING		K0B1122AL	CHEFTOP MM LEFT DOOR LOWER BEAM KIT	<table border="1"> <thead> <tr> <th>Code</th> <th>Description</th> <th>Qty</th> <th>UOM</th> </tr> </thead> <tbody> <tr> <td>RC1200A0</td> <td>ED=4 WIRE D=0.5 H24 COMPRESSIO N SPRING</td> <td>2.000</td> <td>PC</td> </tr> <tr> <td>VI1220A1</td> <td>4,2x12 TCB SELF-TAPPIN G SCREW</td> <td>1.000</td> <td>PC</td> </tr> <tr> <td>VI1996A0</td> <td>M5x35 SCREW</td> <td>7.000</td> <td>PC</td> </tr> <tr> <td>VM1794A0</td> <td>250x4.8 PA66 BLACK CLAMP</td> <td>2.000</td> <td>PC</td> </tr> <tr> <td>VM2267A1</td> <td>INNER GLASS LOCKING SYSTEM SLIDER</td> <td>1.000</td> <td>PC</td> </tr> <tr> <td>VM2269A0</td> <td>INTERNAL GLASS LOCKING SYSTEM CAP</td> <td>1.000</td> <td>PC</td> </tr> <tr> <td>VM2274A0</td> <td>GROOVED BUSHING</td> <td>1.000</td> <td>PC</td> </tr> <tr> <td>VM2305A0</td> <td>MM SERIES DOOR CAP FIXING PAWL</td> <td>7.000</td> <td>PC</td> </tr> <tr> <td>VM2384A0</td> <td>MM LEFT DOOR RIGHT LOWER CAP</td> <td>1.000</td> <td>PC</td> </tr> <tr> <td>VM2386A1</td> <td>LEFT MM DOOR LOWER LEFT CAP</td> <td>1.000</td> <td>PC</td> </tr> </tbody> </table>	Code	Description	Qty	UOM	RC1200A0	ED=4 WIRE D=0.5 H24 COMPRESSIO N SPRING	2.000	PC	VI1220A1	4,2x12 TCB SELF-TAPPIN G SCREW	1.000	PC	VI1996A0	M5x35 SCREW	7.000	PC	VM1794A0	250x4.8 PA66 BLACK CLAMP	2.000	PC	VM2267A1	INNER GLASS LOCKING SYSTEM SLIDER	1.000	PC	VM2269A0	INTERNAL GLASS LOCKING SYSTEM CAP	1.000	PC	VM2274A0	GROOVED BUSHING	1.000	PC	VM2305A0	MM SERIES DOOR CAP FIXING PAWL	7.000	PC	VM2384A0	MM LEFT DOOR RIGHT LOWER CAP	1.000	PC	VM2386A1	LEFT MM DOOR LOWER LEFT CAP	1.000	PC
Code	Description	Qty	UOM																																														
RC1200A0	ED=4 WIRE D=0.5 H24 COMPRESSIO N SPRING	2.000	PC																																														
VI1220A1	4,2x12 TCB SELF-TAPPIN G SCREW	1.000	PC																																														
VI1996A0	M5x35 SCREW	7.000	PC																																														
VM1794A0	250x4.8 PA66 BLACK CLAMP	2.000	PC																																														
VM2267A1	INNER GLASS LOCKING SYSTEM SLIDER	1.000	PC																																														
VM2269A0	INTERNAL GLASS LOCKING SYSTEM CAP	1.000	PC																																														
VM2274A0	GROOVED BUSHING	1.000	PC																																														
VM2305A0	MM SERIES DOOR CAP FIXING PAWL	7.000	PC																																														
VM2384A0	MM LEFT DOOR RIGHT LOWER CAP	1.000	PC																																														
VM2386A1	LEFT MM DOOR LOWER LEFT CAP	1.000	PC																																														
VM2275A	SMOOTH BUSHING		KVM2275A	SMOOTH PIN BUSHING KIT	<table border="1"> <thead> <tr> <th>Code</th> <th>Description</th> <th>Qty</th> <th>UOM</th> </tr> </thead> <tbody> <tr> <td>VM2275A0</td> <td>SMOOTH BUSHING</td> <td>1.000</td> <td>PC</td> </tr> </tbody> </table>	Code	Description	Qty	UOM	VM2275A0	SMOOTH BUSHING	1.000	PC																																				
Code	Description	Qty	UOM																																														
VM2275A0	SMOOTH BUSHING	1.000	PC																																														
VT1217A	357x364x4 SP STEFANIA BLACK EXT GLASS		KVT1217A	SP STEFANIA BLACK EXT GLASS KIT	<table border="1"> <thead> <tr> <th>Code</th> <th>Description</th> <th>Qty</th> <th>UOM</th> </tr> </thead> <tbody> <tr> <td>0B0386A0</td> <td>SP STE-ELE EXT GLASS SUPPORT PROFILE</td> <td>2.000</td> <td>PC</td> </tr> <tr> <td>SL1185A1</td> <td></td> <td>2.000</td> <td>PC</td> </tr> <tr> <td>VI1220A1</td> <td>4,2x12 TCB SELF-TAPPIN G SCREW</td> <td>6.000</td> <td>PC</td> </tr> <tr> <td>VT1217A0</td> <td>357x364x4 SP STEFANIA BLACK EXT GLASS</td> <td>1.000</td> <td>PC</td> </tr> </tbody> </table>	Code	Description	Qty	UOM	0B0386A0	SP STE-ELE EXT GLASS SUPPORT PROFILE	2.000	PC	SL1185A1		2.000	PC	VI1220A1	4,2x12 TCB SELF-TAPPIN G SCREW	6.000	PC	VT1217A0	357x364x4 SP STEFANIA BLACK EXT GLASS	1.000	PC																								
Code	Description	Qty	UOM																																														
0B0386A0	SP STE-ELE EXT GLASS SUPPORT PROFILE	2.000	PC																																														
SL1185A1		2.000	PC																																														
VI1220A1	4,2x12 TCB SELF-TAPPIN G SCREW	6.000	PC																																														
VT1217A0	357x364x4 SP STEFANIA BLACK EXT GLASS	1.000	PC																																														



COMPONENT			SPARE PART																														
Code	Description	Image	Code	Description	Kit components																												
VT1344A	SP STEFANIA FLAG DOOR INNER GLASS+HINGES		KVT1344A	BL SP STEFANIA INT LATERAL GLASS KIT	<table border="1"> <thead> <tr> <th>Code</th> <th>Description</th> <th>Qty</th> <th>UOM</th> </tr> </thead> <tbody> <tr> <td>CR1103A0</td> <td>INTERNAL GLASS ST. STEEL UPPER HINGE</td> <td>1.000</td> <td>PC</td> </tr> <tr> <td>CR1104A0</td> <td>INTERNAL GLASS ST. STEEL LOWER HINGE</td> <td>1.000</td> <td>PC</td> </tr> <tr> <td>VI1810A0</td> <td>M6X6 STAINLESS STEEL FLATHEAD SCREW</td> <td>6.000</td> <td>PC</td> </tr> <tr> <td>VM2399A0</td> <td>DOOR HINGES HEADLESS SCREWS COVER</td> <td>2.000</td> <td>PC</td> </tr> <tr> <td>VM2475A0</td> <td>SP H4 INTERNAL GLASS HINGE INSERT</td> <td>2.000</td> <td>PC</td> </tr> <tr> <td>VT1329A0</td> <td>SP STEFANIA 515x318.5x4 INNER GLASS</td> <td>1.000</td> <td>PC</td> </tr> </tbody> </table>	Code	Description	Qty	UOM	CR1103A0	INTERNAL GLASS ST. STEEL UPPER HINGE	1.000	PC	CR1104A0	INTERNAL GLASS ST. STEEL LOWER HINGE	1.000	PC	VI1810A0	M6X6 STAINLESS STEEL FLATHEAD SCREW	6.000	PC	VM2399A0	DOOR HINGES HEADLESS SCREWS COVER	2.000	PC	VM2475A0	SP H4 INTERNAL GLASS HINGE INSERT	2.000	PC	VT1329A0	SP STEFANIA 515x318.5x4 INNER GLASS	1.000	PC
					Code	Description	Qty	UOM																									
					CR1103A0	INTERNAL GLASS ST. STEEL UPPER HINGE	1.000	PC																									
					CR1104A0	INTERNAL GLASS ST. STEEL LOWER HINGE	1.000	PC																									
					VI1810A0	M6X6 STAINLESS STEEL FLATHEAD SCREW	6.000	PC																									
					VM2399A0	DOOR HINGES HEADLESS SCREWS COVER	2.000	PC																									
					VM2475A0	SP H4 INTERNAL GLASS HINGE INSERT	2.000	PC																									
VT1329A0	SP STEFANIA 515x318.5x4 INNER GLASS	1.000	PC																														



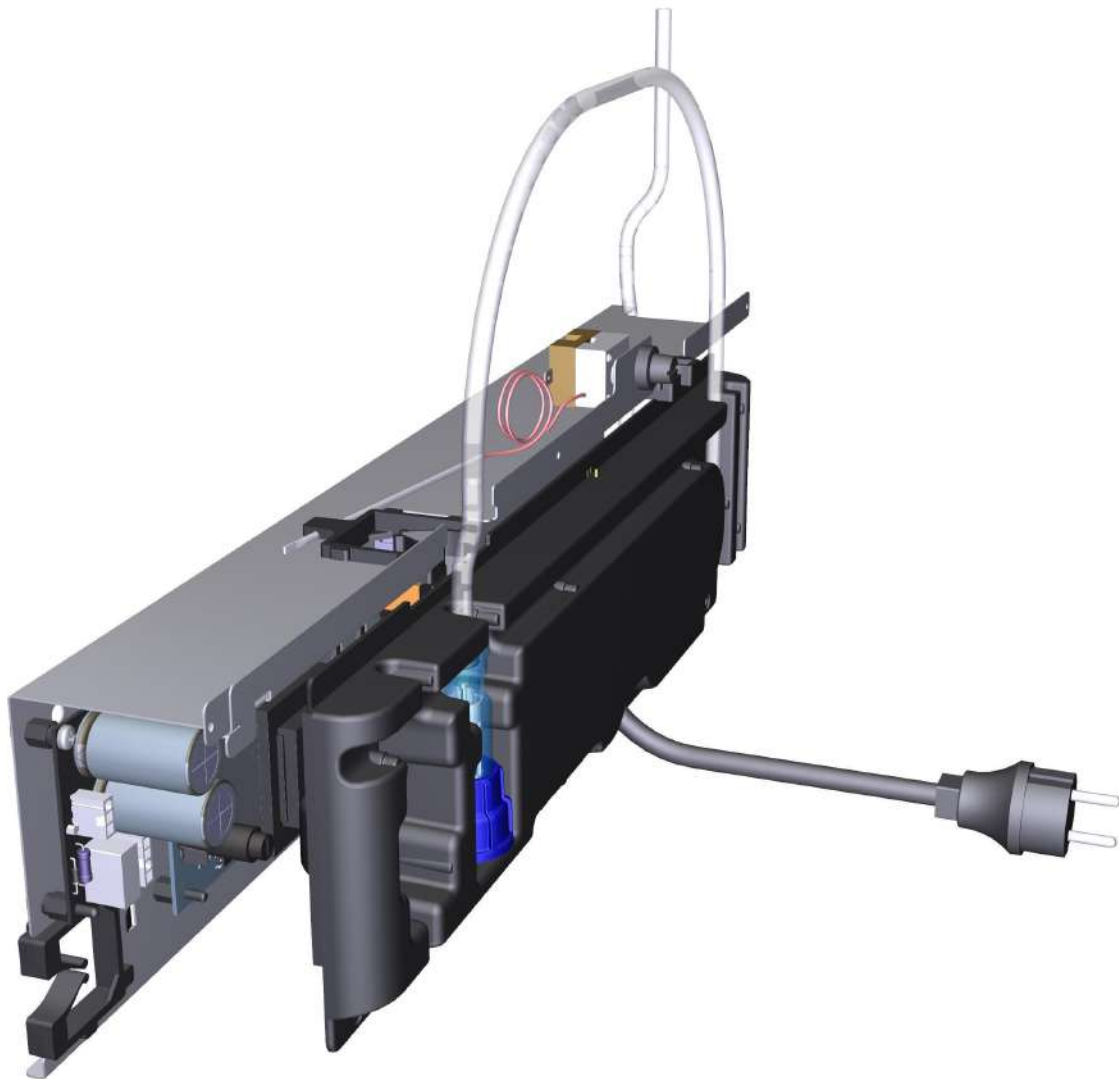

ASM8225A/0.D00 - Electrical system - FRONT







ASM8225A/0.D00 - Electrical system - REAR





COMPONENT			SPARE PART																										
Code	Description	Image	Code	Description	Kit components																								
0P1052A	SP600 SINGLE MOTOR BOARD WIRING HOLDER		0P1052A0	SP600 SINGLE MOTOR BOARD WIRING HOLDER																									
VL1145A	VL1145A1		KVL1145A	3/4-JG8 FITTING WITH FILTER AND NRV KIT	<table border="1"> <thead> <tr> <th>Code</th> <th>Description</th> <th>Qty</th> <th>UOM</th> </tr> </thead> <tbody> <tr> <td>VL1145A1</td> <td>VL1145A1</td> <td>1.000</td> <td>PC</td> </tr> </tbody> </table>	Code	Description	Qty	UOM	VL1145A1	VL1145A1	1.000	PC																
Code	Description	Qty	UOM																										
VL1145A1	VL1145A1	1.000	PC																										
PE2117A	BLSP ELECTROMECHANICAL LOCK BOARD		KPE2117A	ELECTRIC LOCKING SYSTEM BOARD KIT 230V	<table border="1"> <thead> <tr> <th>Code</th> <th>Description</th> <th>Qty</th> <th>UOM</th> </tr> </thead> <tbody> <tr> <td>PE2117A0</td> <td>BLSP ELECTROMECHANICAL LOCK BOARD</td> <td>1.000</td> <td>PC</td> </tr> <tr> <td>VI1850A0</td> <td>TCB M4x6 SCREW</td> <td>2.000</td> <td>PC</td> </tr> <tr> <td>VM1447A0</td> <td></td> <td>0.500</td> <td>PC</td> </tr> <tr> <td>VM1746A0</td> <td>H10 M4 JOINT BOARD FASTENING CLIP</td> <td>2.000</td> <td>PC</td> </tr> <tr> <td>VM1747A0</td> <td>JOINT-PIN H10 POWER BOARD FASTENING CLIP</td> <td>2.000</td> <td>PC</td> </tr> </tbody> </table>	Code	Description	Qty	UOM	PE2117A0	BLSP ELECTROMECHANICAL LOCK BOARD	1.000	PC	VI1850A0	TCB M4x6 SCREW	2.000	PC	VM1447A0		0.500	PC	VM1746A0	H10 M4 JOINT BOARD FASTENING CLIP	2.000	PC	VM1747A0	JOINT-PIN H10 POWER BOARD FASTENING CLIP	2.000	PC
Code	Description	Qty	UOM																										
PE2117A0	BLSP ELECTROMECHANICAL LOCK BOARD	1.000	PC																										
VI1850A0	TCB M4x6 SCREW	2.000	PC																										
VM1447A0		0.500	PC																										
VM1746A0	H10 M4 JOINT BOARD FASTENING CLIP	2.000	PC																										
VM1747A0	JOINT-PIN H10 POWER BOARD FASTENING CLIP	2.000	PC																										
VM1746A	H10 M4 JOINT BOARD FASTENING CLIP		KVM1746A	BOARD FIXING CLIP JOINT-M4 KIT	<table border="1"> <thead> <tr> <th>Code</th> <th>Description</th> <th>Qty</th> <th>UOM</th> </tr> </thead> <tbody> <tr> <td>VM1746A0</td> <td>H10 M4 JOINT BOARD FASTENING CLIP</td> <td>10.000</td> <td>PC</td> </tr> </tbody> </table>	Code	Description	Qty	UOM	VM1746A0	H10 M4 JOINT BOARD FASTENING CLIP	10.000	PC																
Code	Description	Qty	UOM																										
VM1746A0	H10 M4 JOINT BOARD FASTENING CLIP	10.000	PC																										

COMPONENT			SPARE PART																										
Code	Description	Image	Code	Description	Kit components																								
VM1747A	JOINT-PIN H10 POWER BOARD FASTENING CLIP		KVM1747A	BOARD FIXING CLIP JOINT-PIN KIT	<table border="1"> <thead> <tr> <th>Code</th> <th>Description</th> <th>Qty</th> <th>UOM</th> </tr> </thead> <tbody> <tr> <td>VM1747A0</td> <td>JOINT-PIN H10 POWER BOARD FASTENING CLIP</td> <td>10.000</td> <td>PC</td> </tr> </tbody> </table>	Code	Description	Qty	UOM	VM1747A0	JOINT-PIN H10 POWER BOARD FASTENING CLIP	10.000	PC																
Code	Description	Qty	UOM																										
VM1747A0	JOINT-PIN H10 POWER BOARD FASTENING CLIP	10.000	PC																										
PE1463A	SHOP.Pro 230V 03HS-04HS POWER CARD		KPE1463A	SHOP.Pro 230V 03HS-04HS POWER CARD KIT	<table border="1"> <thead> <tr> <th>Code</th> <th>Description</th> <th>Qty</th> <th>UOM</th> </tr> </thead> <tbody> <tr> <td>PE1463A0</td> <td>SHOP.Pro 230V 03HS-04HS POWER CARD</td> <td>1.000</td> <td>PC</td> </tr> <tr> <td>VI1988A0</td> <td>AUTOTHREAD ING SCREW 4,2x19 TCB+ INOX</td> <td>3.000</td> <td>PC</td> </tr> <tr> <td>VM1187A0</td> <td>POWER BOARD FRAME SHOP.PRO</td> <td>1.000</td> <td>PC</td> </tr> <tr> <td>VM1447A0</td> <td></td> <td>1.000</td> <td>PC</td> </tr> <tr> <td>VM1748A0</td> <td>JOINT-JOINT H10 BOARD FIXING CLIP</td> <td>6.000</td> <td>PC</td> </tr> </tbody> </table>	Code	Description	Qty	UOM	PE1463A0	SHOP.Pro 230V 03HS-04HS POWER CARD	1.000	PC	VI1988A0	AUTOTHREAD ING SCREW 4,2x19 TCB+ INOX	3.000	PC	VM1187A0	POWER BOARD FRAME SHOP.PRO	1.000	PC	VM1447A0		1.000	PC	VM1748A0	JOINT-JOINT H10 BOARD FIXING CLIP	6.000	PC
Code	Description	Qty	UOM																										
PE1463A0	SHOP.Pro 230V 03HS-04HS POWER CARD	1.000	PC																										
VI1988A0	AUTOTHREAD ING SCREW 4,2x19 TCB+ INOX	3.000	PC																										
VM1187A0	POWER BOARD FRAME SHOP.PRO	1.000	PC																										
VM1447A0		1.000	PC																										
VM1748A0	JOINT-JOINT H10 BOARD FIXING CLIP	6.000	PC																										
VM1748A	JOINT-JOINT H10 BOARD FIXING CLIP		VM1748A0	JOINT-JOINT H10 BOARD FIXING CLIP																									
CE1581A	CABLE H07RNF 3G1.5 L1.5MT+K1/6+SCHU KO		KCE1581A	H07RNF 3G1.5 L1.5 MT + SHUKO PLUG KIT	<table border="1"> <thead> <tr> <th>Code</th> <th>Description</th> <th>Qty</th> <th>UOM</th> </tr> </thead> <tbody> <tr> <td>CE1581A0</td> <td>CABLE H07RNF 3G1.5 L1.5MT+K1/6+ SCHUKO</td> <td>1.000</td> <td>PC</td> </tr> </tbody> </table>	Code	Description	Qty	UOM	CE1581A0	CABLE H07RNF 3G1.5 L1.5MT+K1/6+ SCHUKO	1.000	PC																
Code	Description	Qty	UOM																										
CE1581A0	CABLE H07RNF 3G1.5 L1.5MT+K1/6+ SCHUKO	1.000	PC																										

COMPONENT			SPARE PART																										
Code	Description	Image	Code	Description	Kit components																								
CN1003A	6,3 Uf MOTOR CAPACITOR		KCN1003A	6,3 uF MOTOR CAPACITOR KIT	<table border="1"> <thead> <tr> <th>Code</th> <th>Description</th> <th>Qty</th> <th>UOM</th> </tr> </thead> <tbody> <tr> <td>CN1003A0</td> <td>6,3 Uf MOTOR CAPACITOR</td> <td>1.000</td> <td>PC</td> </tr> <tr> <td>VI1931A0</td> <td>M8x1.65 H4 CH13 ZINC PLATED NUT</td> <td>1.000</td> <td>PC</td> </tr> <tr> <td>VI1932A0</td> <td>D8 INDENTED ZINC PLATED WASHER</td> <td>1.000</td> <td>PC</td> </tr> </tbody> </table>	Code	Description	Qty	UOM	CN1003A0	6,3 Uf MOTOR CAPACITOR	1.000	PC	VI1931A0	M8x1.65 H4 CH13 ZINC PLATED NUT	1.000	PC	VI1932A0	D8 INDENTED ZINC PLATED WASHER	1.000	PC								
					Code	Description	Qty	UOM																					
CN1003A0	6,3 Uf MOTOR CAPACITOR	1.000	PC																										
VI1931A0	M8x1.65 H4 CH13 ZINC PLATED NUT	1.000	PC																										
VI1932A0	D8 INDENTED ZINC PLATED WASHER	1.000	PC																										
RC1006A	D8 PET PIPE GUIDE BEND		KRC1006A	20 PCS. Ø8 PET PIPE GUIDE BEND KI	<table border="1"> <thead> <tr> <th>Code</th> <th>Description</th> <th>Qty</th> <th>UOM</th> </tr> </thead> <tbody> <tr> <td>RC1006A0</td> <td>D8 PET PIPE GUIDE BEND</td> <td>20.000</td> <td>PC</td> </tr> </tbody> </table>	Code	Description	Qty	UOM	RC1006A0	D8 PET PIPE GUIDE BEND	20.000	PC																
Code	Description	Qty	UOM																										
RC1006A0	D8 PET PIPE GUIDE BEND	20.000	PC																										
TB3280A	TB3280A0		KTB2529A	Ø8 TRANSPARENT HUMIDITY PIPE 2 M KIT	<table border="1"> <thead> <tr> <th>Code</th> <th>Description</th> <th>Qty</th> <th>UOM</th> </tr> </thead> <tbody> <tr> <td>TB1815A0</td> <td>7,93x4,75 PE TRANSP. PIPE (JG #PE08100N)</td> <td>2.000</td> <td>M</td> </tr> </tbody> </table>	Code	Description	Qty	UOM	TB1815A0	7,93x4,75 PE TRANSP. PIPE (JG #PE08100N)	2.000	M																
					Code	Description	Qty	UOM																					
TB1815A0	7,93x4,75 PE TRANSP. PIPE (JG #PE08100N)	2.000	M																										
KTB1959A	Ø8 TB1815 TRANSPARENT PIPE 5M KIT	<table border="1"> <thead> <tr> <th>Code</th> <th>Description</th> <th>Qty</th> <th>UOM</th> </tr> </thead> <tbody> <tr> <td>TB1815A0</td> <td>7,93x4,75 PE TRANSP. PIPE (JG #PE08100N)</td> <td>5.000</td> <td>M</td> </tr> </tbody> </table>	Code	Description	Qty	UOM	TB1815A0	7,93x4,75 PE TRANSP. PIPE (JG #PE08100N)	5.000	M																			
Code	Description	Qty	UOM																										
TB1815A0	7,93x4,75 PE TRANSP. PIPE (JG #PE08100N)	5.000	M																										
TR1136A	318°C -0/+24 1 POLE SAFETY THERMOSTAT		KTR1136A	318°C -0/+24 SAFETY THERMOSTAT KIT	<table border="1"> <thead> <tr> <th>Code</th> <th>Description</th> <th>Qty</th> <th>UOM</th> </tr> </thead> <tbody> <tr> <td>0H8120A0</td> <td>XEVL BULB PASS-THROU GH COVER</td> <td>1.000</td> <td>PC</td> </tr> <tr> <td>GN1531A0</td> <td>THERMOSTAT BULB INLET SEALING</td> <td>1.000</td> <td>PC</td> </tr> <tr> <td>SL1045A0</td> <td>S57 BLACK SILICONE - 80ml CARTRIDGE</td> <td>1.000</td> <td>PC</td> </tr> <tr> <td>TR1136A0</td> <td>318°C -0/+24 1 POLE SAFETY THERMOSTAT</td> <td>1.000</td> <td>PC</td> </tr> <tr> <td>VI1220A1</td> <td>4,2x12 TCB SELF-TAPPIN G SCREW</td> <td>3.000</td> <td>PC</td> </tr> </tbody> </table>	Code	Description	Qty	UOM	0H8120A0	XEVL BULB PASS-THROU GH COVER	1.000	PC	GN1531A0	THERMOSTAT BULB INLET SEALING	1.000	PC	SL1045A0	S57 BLACK SILICONE - 80ml CARTRIDGE	1.000	PC	TR1136A0	318°C -0/+24 1 POLE SAFETY THERMOSTAT	1.000	PC	VI1220A1	4,2x12 TCB SELF-TAPPIN G SCREW	3.000	PC
					Code	Description	Qty	UOM																					
					0H8120A0	XEVL BULB PASS-THROU GH COVER	1.000	PC																					
					GN1531A0	THERMOSTAT BULB INLET SEALING	1.000	PC																					
					SL1045A0	S57 BLACK SILICONE - 80ml CARTRIDGE	1.000	PC																					
TR1136A0	318°C -0/+24 1 POLE SAFETY THERMOSTAT	1.000	PC																										
VI1220A1	4,2x12 TCB SELF-TAPPIN G SCREW	3.000	PC																										



COMPONENT			SPARE PART																		
Code	Description	Image	Code	Description	Kit components																
VI1328A	VI1328A0		VI1328A0	VI1328A0																	
VM1188A	POWER BOARD WIRES PASS-THROUGH		KVM1188A	POWER BOARD WIRES PASS-THROUGH 10PCS KIT	<table border="1"> <thead> <tr> <th>Code</th> <th>Description</th> <th>Qty</th> <th>UOM</th> </tr> </thead> <tbody> <tr> <td>VM1188A0</td> <td>POWER BOARD WIRES PASS-THROUGH</td> <td>10.000</td> <td>PC</td> </tr> </tbody> </table>	Code	Description	Qty	UOM	VM1188A0	POWER BOARD WIRES PASS-THROUGH	10.000	PC								
Code	Description	Qty	UOM																		
VM1188A0	POWER BOARD WIRES PASS-THROUGH	10.000	PC																		
VM2482A	ELECTR COMPONENTS HOLDER FRAME SHOP.PRO		KVM2482A	BAKERLUX SP ELECTR COMPONENTS HOLDER KIT	<table border="1"> <thead> <tr> <th>Code</th> <th>Description</th> <th>Qty</th> <th>UOM</th> </tr> </thead> <tbody> <tr> <td>VM2482A0</td> <td>ELECTR COMPONENTS HOLDER FRAME SHOP.PRO</td> <td>1.000</td> <td>PC</td> </tr> <tr> <td>VM2484A0</td> <td>ELECTRICAL CONNECTION CABLE CLAMP</td> <td>1.000</td> <td>PC</td> </tr> </tbody> </table>	Code	Description	Qty	UOM	VM2482A0	ELECTR COMPONENTS HOLDER FRAME SHOP.PRO	1.000	PC	VM2484A0	ELECTRICAL CONNECTION CABLE CLAMP	1.000	PC				
Code	Description	Qty	UOM																		
VM2482A0	ELECTR COMPONENTS HOLDER FRAME SHOP.PRO	1.000	PC																		
VM2484A0	ELECTRICAL CONNECTION CABLE CLAMP	1.000	PC																		
VM2483A	SHOP PRO COMPONENTS HOLDER COVER		KVM2483A	BL SHOP.PRO COMPONENTS HOLDER COVER KIT	<table border="1"> <thead> <tr> <th>Code</th> <th>Description</th> <th>Qty</th> <th>UOM</th> </tr> </thead> <tbody> <tr> <td>VM2483A1</td> <td>SHOP PRO COMPONENTS HOLDER COVER</td> <td>1.000</td> <td>PC</td> </tr> </tbody> </table>	Code	Description	Qty	UOM	VM2483A1	SHOP PRO COMPONENTS HOLDER COVER	1.000	PC								
Code	Description	Qty	UOM																		
VM2483A1	SHOP PRO COMPONENTS HOLDER COVER	1.000	PC																		
VM2484A	ELECTRICAL CONNECTION CABLE CLAMP		KVM2484A KVM2482A	CABLE LOCKS ELECTRICAL CONNECTION KIT BAKERLUX SP ELECTR COMPONENTS HOLDER KIT	<table border="1"> <thead> <tr> <th>Code</th> <th>Description</th> <th>Qty</th> <th>UOM</th> </tr> </thead> <tbody> <tr> <td>VM2484A0</td> <td>ELECTRICAL CONNECTION CABLE CLAMP</td> <td>1.000</td> <td>PC</td> </tr> <tr> <td>VM2482A0</td> <td>ELECTR COMPONENTS HOLDER FRAME SHOP.PRO</td> <td>1.000</td> <td>PC</td> </tr> <tr> <td>VM2484A0</td> <td>ELECTRICAL CONNECTION CABLE CLAMP</td> <td>1.000</td> <td>PC</td> </tr> </tbody> </table>	Code	Description	Qty	UOM	VM2484A0	ELECTRICAL CONNECTION CABLE CLAMP	1.000	PC	VM2482A0	ELECTR COMPONENTS HOLDER FRAME SHOP.PRO	1.000	PC	VM2484A0	ELECTRICAL CONNECTION CABLE CLAMP	1.000	PC
Code	Description	Qty	UOM																		
VM2484A0	ELECTRICAL CONNECTION CABLE CLAMP	1.000	PC																		
VM2482A0	ELECTR COMPONENTS HOLDER FRAME SHOP.PRO	1.000	PC																		
VM2484A0	ELECTRICAL CONNECTION CABLE CLAMP	1.000	PC																		